

drawn left

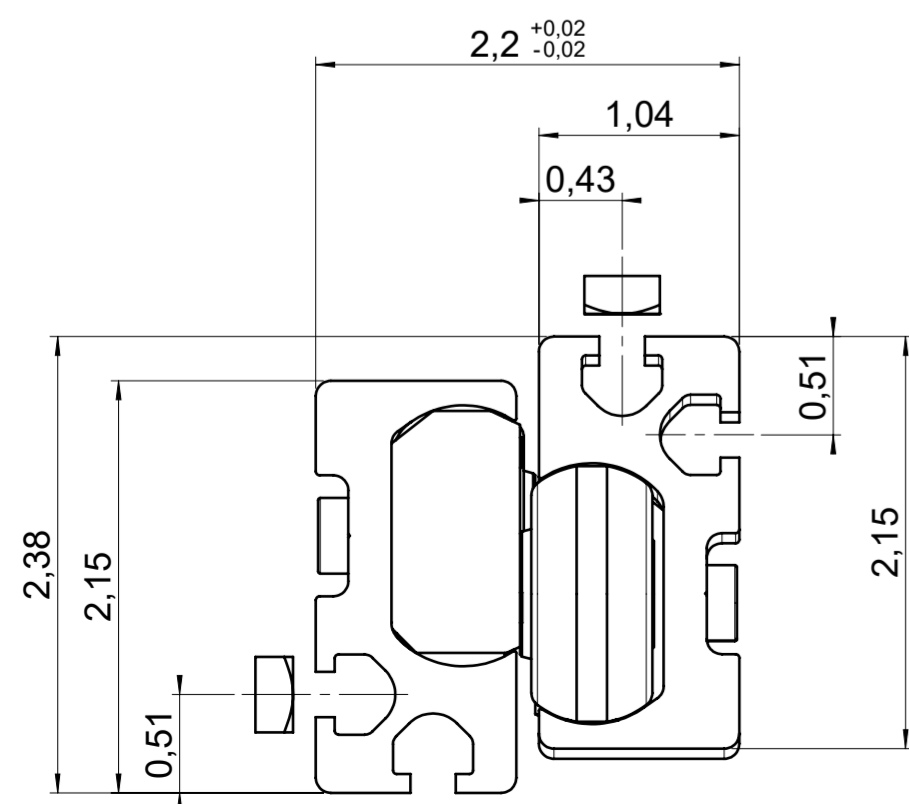
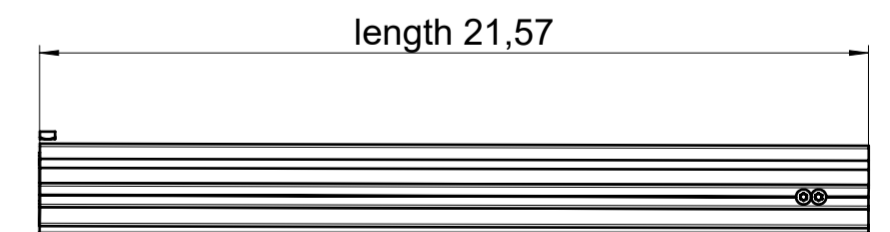
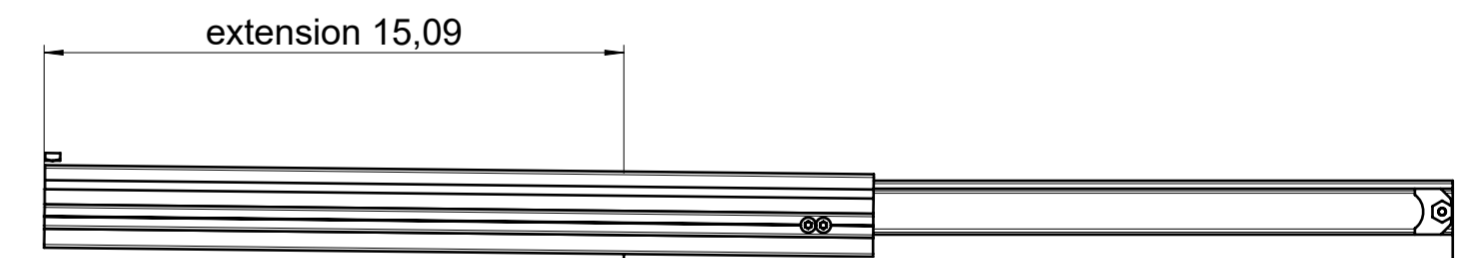
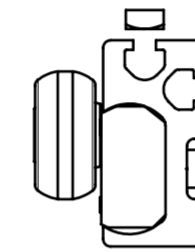
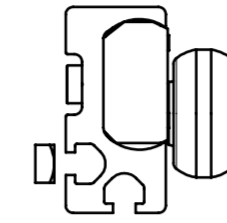
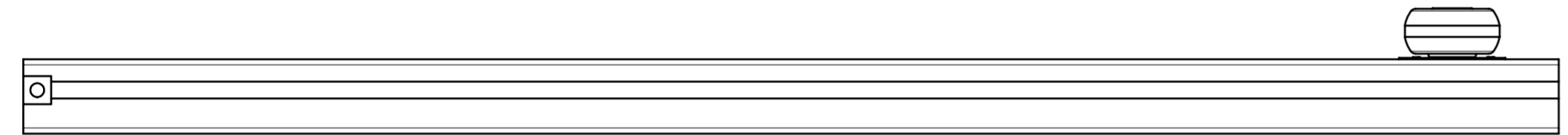

**final approval**

customer name:

signed by:

date:

**all dimensions in inch**

DIN ISO 128-30  
missing dimensions see 3D  
= theor. intersection

This drawing remains our property and may not be multiplied neither be disclosed to third parties (§§1,3 and 5 from the copyright Act (UrhG)) covered according to DIN ISO 16016				scale: 1:2	surface:	material, semi finished parts: CS (technical requirements Fulterer)	A2
(k)				date	name	description: FR 9000 / 55 EN (inch) progressive-action full-extension drawerslide / side mount	drawing number: <b>9000.550-GA.0000.li</b> replaces version date:
(l)			drawn 01-02-2023	ex			
(h)			proven 01-03-2023	pr			
(g)							
(f)							
(e)							
(d)							
(c)							
(b)							
(a)							
ind.	changes	date	na.				

drawn right

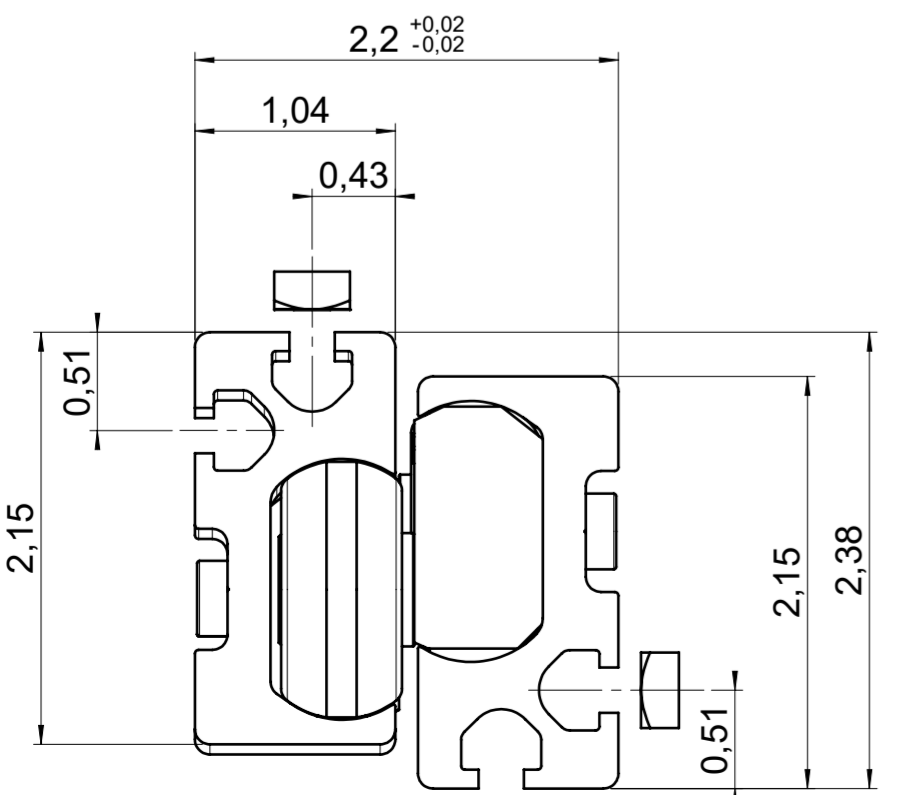
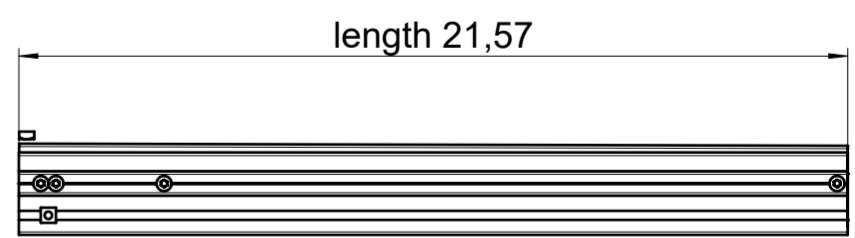
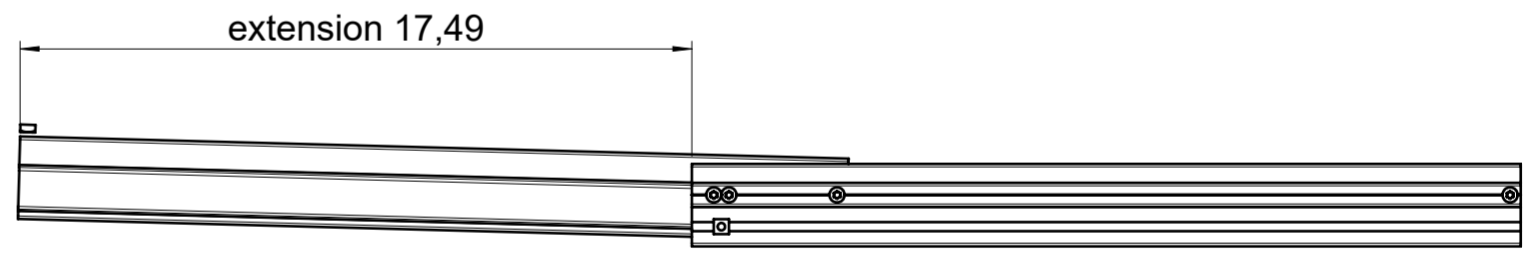
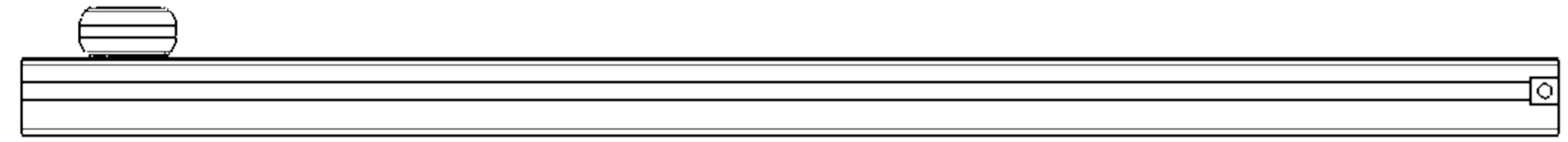
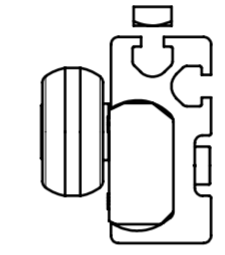
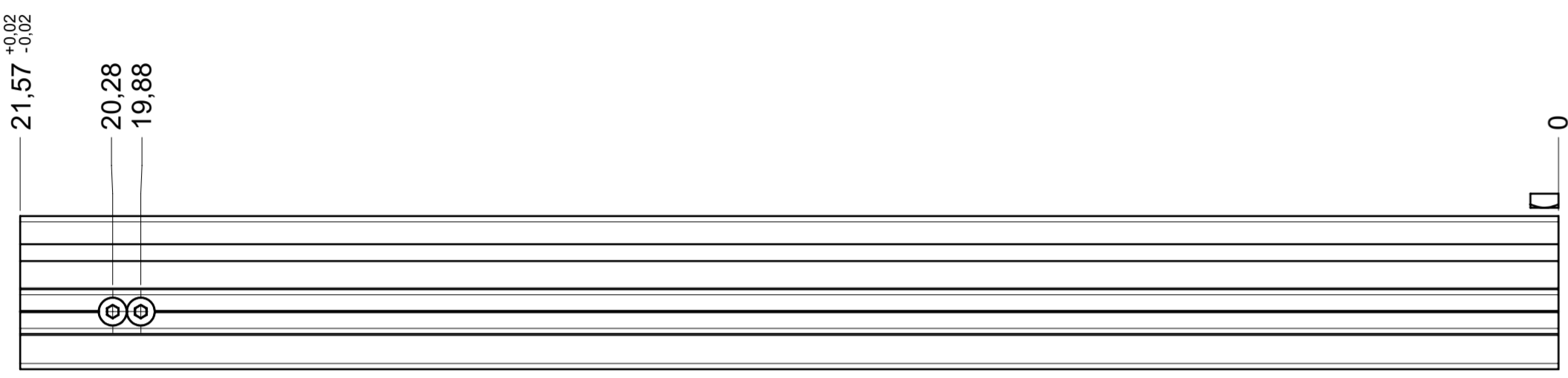
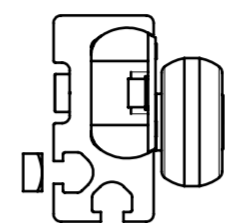
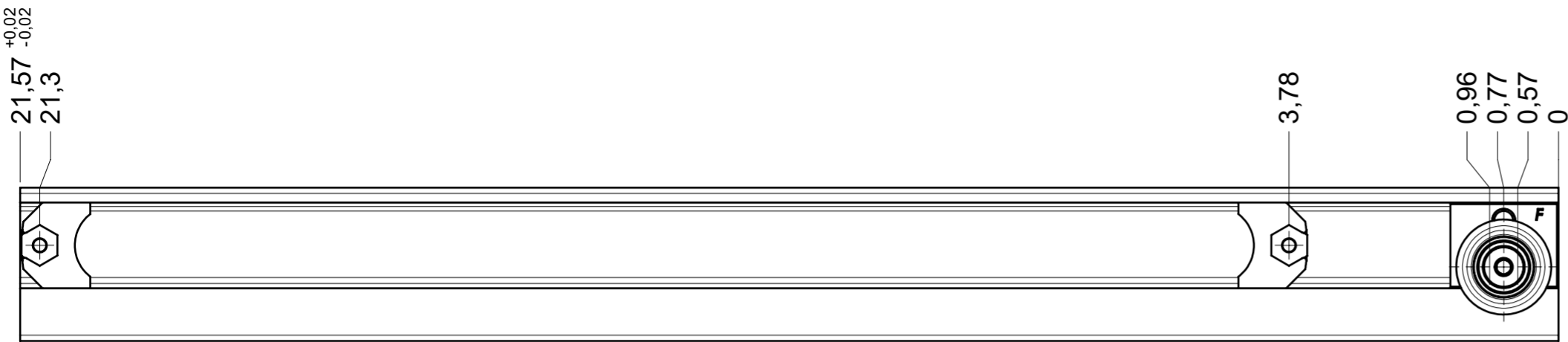

**final approval**

customer name:

signed by:

date:

**all dimensions in inch**

DIN ISO 128-30  
missing dimensions see 3D  
= theor. intersection

This drawing remains our property and may not be multiplied neither be disclosed to third parties (§§1,3 and 5 from the copyright Act (UrhG)) covered according to DIN ISO 16016				scale: 1:2	surface:	material, semi finished parts: CS (technical requirements Fulterer)	A2
(k)				date	name	description: FR 9000 / 55 EN (inch) progressive-action full-extension drawerslide / side mount	drawing number: 9000.550-GA.0000.re
(l)				drawn 01-02-2023	ex		
(h)				proven 01-03-2023	pr		
(g)				<b>Fulterer</b>		drawing number: 9000.550-GA.0000.re	replaces version date:
(f)				Fulterer AG & Co KG			
(e)				A-6890 Lustenau / Austria			
(d)				Fulterer AG			
(c)				CH-9430 St. Margrethen			
(b)				changes	date	na.	
(a)							