

SCALE 1:1

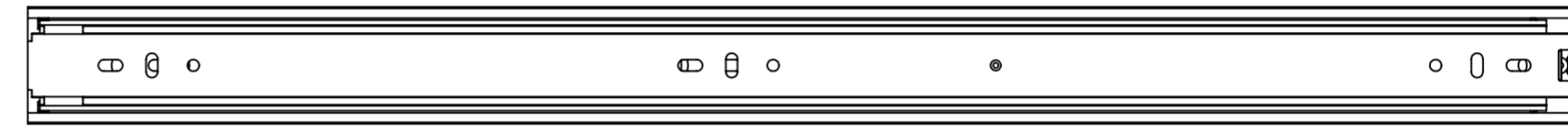

CABINET MOUNTING HOLES

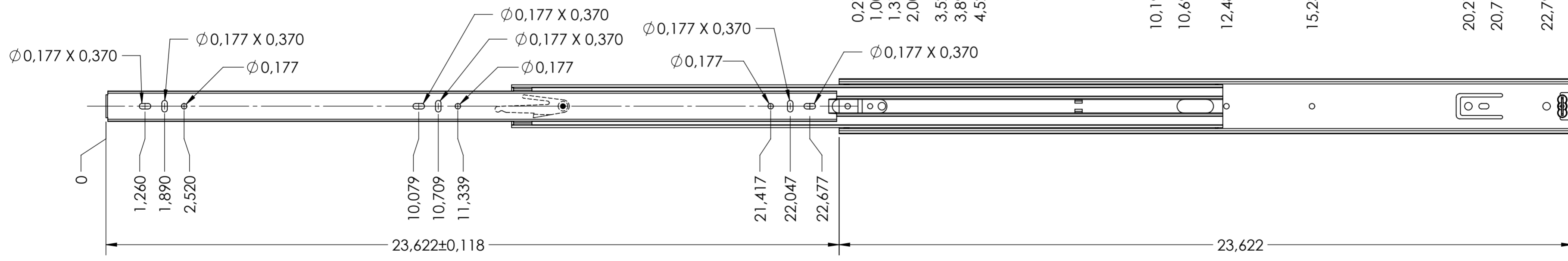
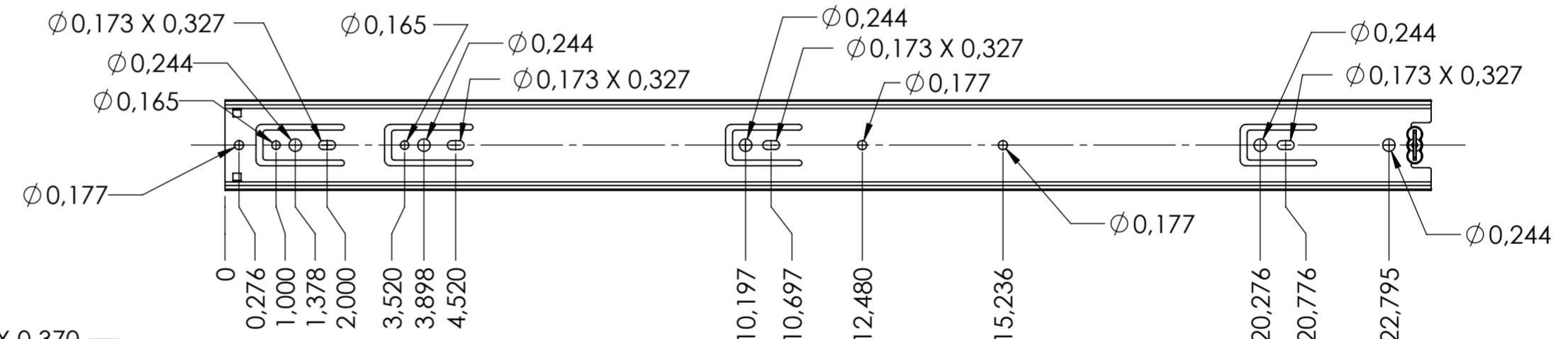

RECOMMENDED HARDWARE:
 CABINET- 3.5mm SPAX M4 BUTTON HEAD OR #8 TRUSS HEAD SCREW
 DRAWER- 3.5mm SPAX M4 BUTTON HEAD OR #8 TRUSS HEAD SCREW

general tolerances		DIN ISO 128-30 missing dimensions see 3D = theor. intersection	
ISO 2768-m			
This drawing remains our property and may not be multiplied neither be disclosed to third parties (§§1,3 and 5 from the copyright Act (UrhG))			
covered according to DIN ISO 16016		scale: 3:8	surface: A2
(k)		date	name
(l)		drawn 15-10-2019	HB
(m)		proven 00-00-0000	00
(n)		Fulterer	
(o)			
(p)		Fulterer AG & Co KG A-6890 Lustenau / Austria	
(q)		Fulterer AG CH-9430 St. Margrethen	
(r)		drawing number: 5045.600-GA.C000A	
(s)		replaces version date:	
(t)			
(u)			
(v)			
(w)			
(x)			
(y)			
(z)			
ind.	changes	date	na.