

CABINET MOUNTING HOLES

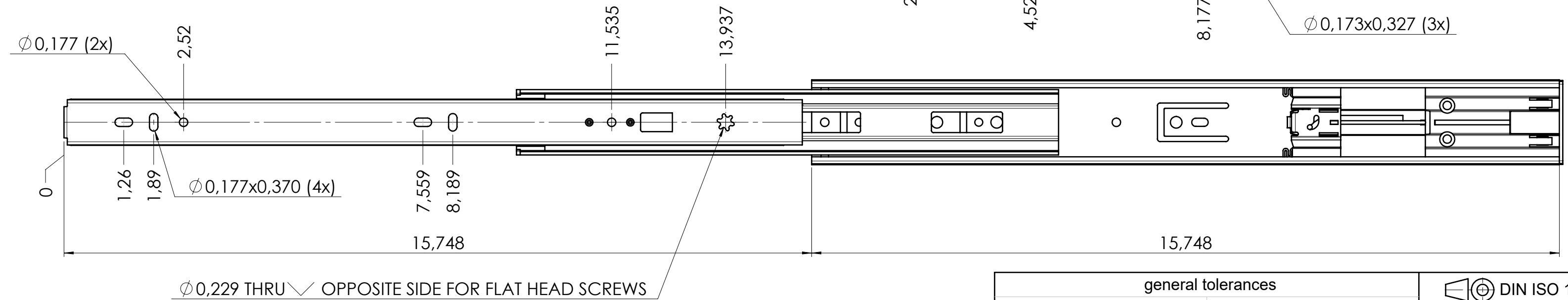
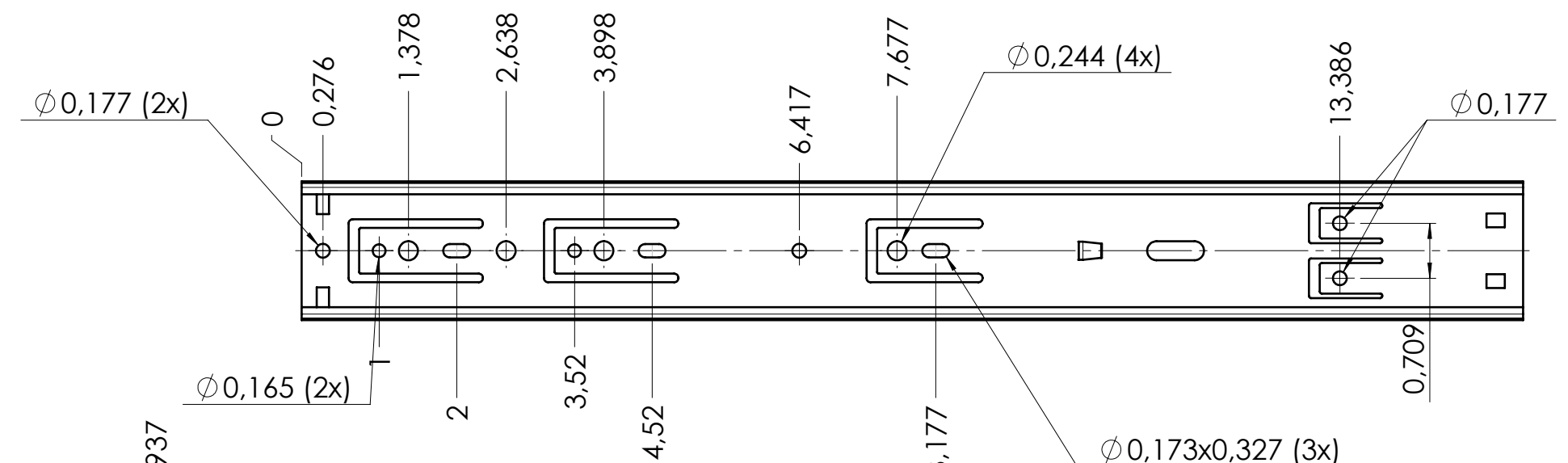

RECOMMENDED HARDWARE:
 CABINET- 3.5mm SPAX M4 BUTTON HEAD OR #8 TRUSS HEAD SCREW
 DRAWER- 3.5mm SPAX M4 BUTTON HEAD OR #8 TRUSS HEAD SCREW

general tolerances		DIN ISO 128-30	
stamping part according Fulterer W18-001	plastic part according DIN ISO 16742 TG4	missing dimensions see 3D = theor. intersection	
This drawing remains our property and may not be multiplied neither be disclosed to third parties (§§1,3 and 5 from the copyright Act (UrhG))			
covered according to DIN ISO 16016		scale: 1:2	surface: A2
(k)		date	name
(l)		drawn 09-12-2020	MW
(m)		proven 00-00-0000	00
(n)		Fulterer	
(o)			
(p)		description: SIDE MOUNT FULL EXTENSION DRAWER SLIDE WITH SOFT- CLOSE & DRAWER DISCONNECT	
(q)		drawing number: 5046.400-GA.C001A	
(r)		replaces version date:	
(s)		drawing number: 5046.400-GA.C001A	
(t)		replaces version date:	
(u)		drawing number: 5046.400-GA.C001A	
(v)		replaces version date:	
(w)		drawing number: 5046.400-GA.C001A	
(x)		replaces version date:	
(y)		drawing number: 5046.400-GA.C001A	
(z)		replaces version date:	
ind.	Lochposition angepasst changes	16-04-2021 date	MW na.