

CABINET MOUNTING HOLES

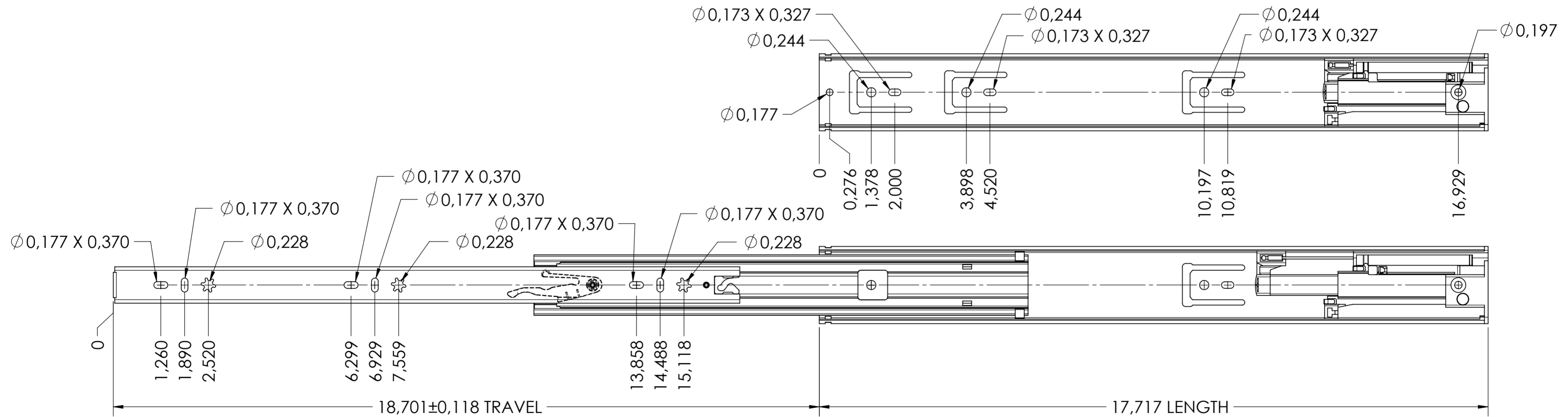

RECOMMENDED HARDWARE:

CABINET- M4 BUTTON HEAD M5 FLATHEAD #8 TRUSS HEAD #10 FLAT HEAD SCREW

DRAWER- M4 BUTTON HEAD M5 FLATHEAD #8 TRUSS HEAD #10 FLAT HEAD SCREW

general tolerances		DIN ISO 128-30 missing dimensions see 3D = theor. intersection	
ISO 2768-m			
This drawing remains our property and may not be multiplied neither be disclosed to third parties (§§1,3 and 5 from the copyright Act (UrhG)) covered according to DIN ISO 16016			
(k)		scale:	surface:
(l)		1:2	
(m)		date	name
(n)		drawn 14-02-2019	HB
(o)		proven 00-00-0000	00
(p)		Fulterer	
(q)			
(r)		Fulterer AG & Co KG A-6890 Lustenau / Austria	
(s)		Fulterer AG CH-9430 St. Margrethen	
(t)		drawing number: 5210.450-GA.T031	
(u)		replaces version date:	
(v)		ind.	changes
(w)		date	na.
(x)		00-00-0000	0