

CABINET MOUNTING HOLES

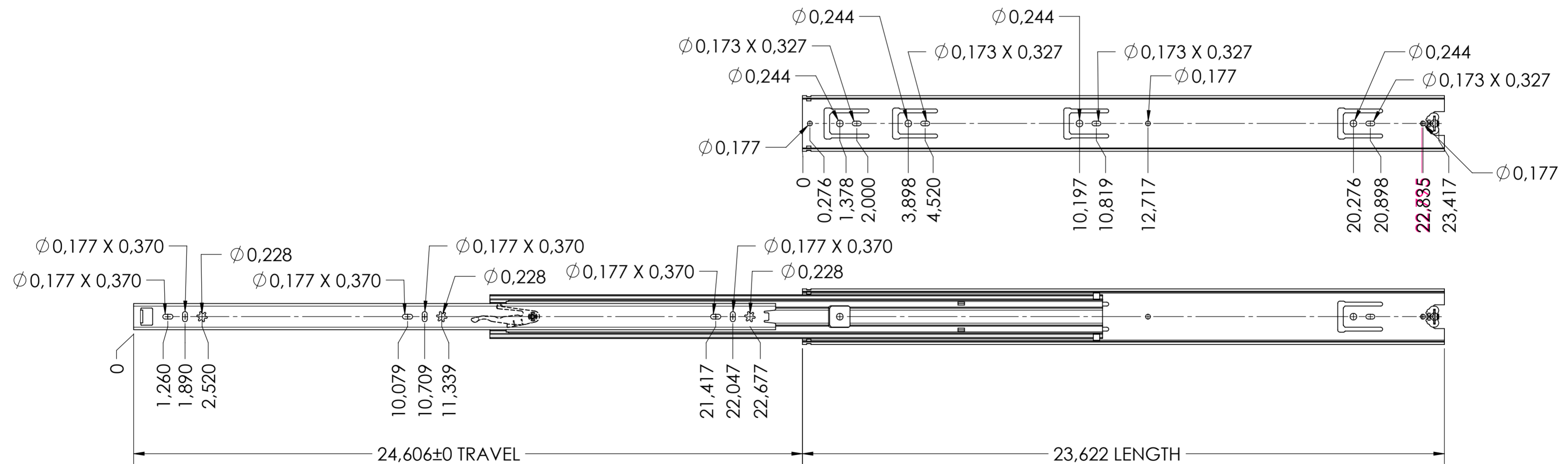

RECOMMENDED HARDWARE:

CABINET- M4 BUTTON HEAD M5 FLATHEAD #8 TRUSS HEAD #10 FLAT HEAD SCREW

DRAWER- M4 BUTTON HEAD M5 FLATHEAD #8 TRUSS HEAD #10 FLAT HEAD SCREW

general tolerances		missing dimensions see 3D = theor. intersection	
ISO 2768-m			
This drawing remains our property and may not be multiplied neither be disclosed to third parties (§§1,3 and 5 from the copyright Act (UrhG)) covered according to DIN ISO 16016			
(k)		scale:	surface:
(l)		1:3	
(m)		date	name
(n)		drawn 06-11-2018	HB
(o)		proven 00-00-0000	00
(p)		Fulterer	
(q)			
(r)		Fulterer AG & Co KG	
(s)		A-6890 Lustenau / Austria	
(t)		Fulterer AG	
(u)		CH-9430 St. Margrethen	
(v)		drawing number:	
(w)		5210.600-GA.T030	
(x)		replaces version date:	
(y)			
(z)			
ind.	changes	date	na.