

SCALE 1:1

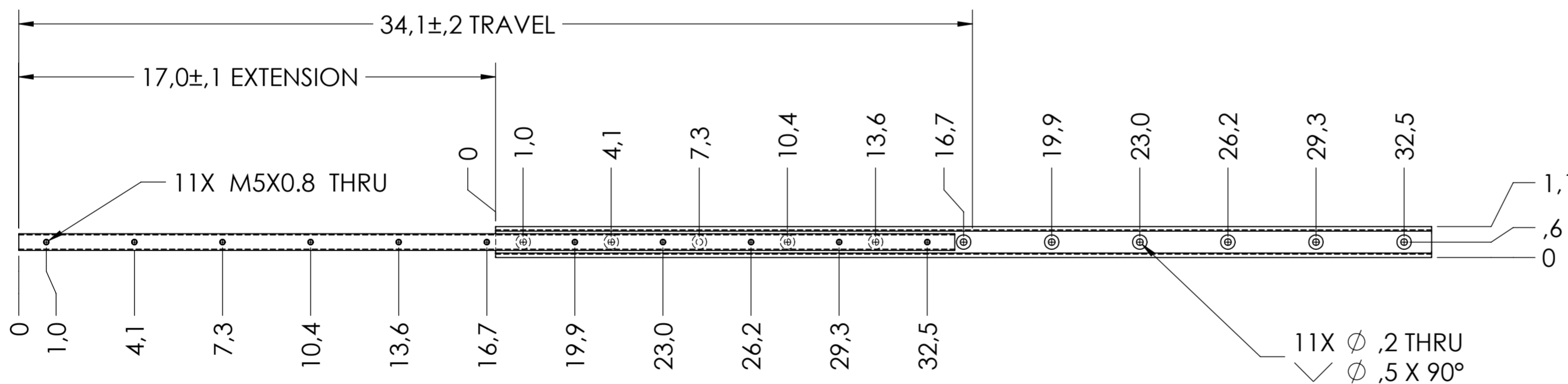
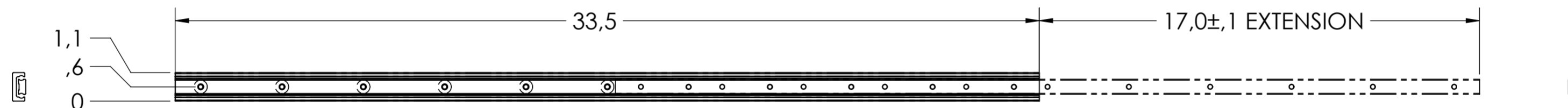

RECOMMENDED HARDWARE:
CABINET- M5 FLAT HEAD SCREWS

DRAWER- M5 x .8 SCREWS

X

general tolerances		DIN ISO 128-30 missing dimensions see 3D = theor. intersection	
ISO 2768-m			
This drawing remains our property and may not be multiplied neither be disclosed to third parties (§§1,3 and 5 from the copyright Act (UrhG)) covered according to DIN ISO 16016			
(k)	scale:	surface:	material, semi finished parts:
(l)	1:41:4		STEEL
(m)	date	name	(technical requirements Fulterer)
(n)	drawn 23-07-2018	HB	description: TWO-WAY TRAVEL SIDE MOUNT TWO-WAY TRAVEL SIDE MOUNT SUPER HEAVY DUTY SLIDE
(o)	proven 00-00-0000	00	
(p)	Fulterer		drawing number: 5328.850-GA.T091
(q)			
(r)	Fulterer AG CH-9430 St. Margrethen		replaces version date:
(s)	ind.	changes	date
(t)	0	00-00-0000	0