

CABINET MOUNTING HOLES

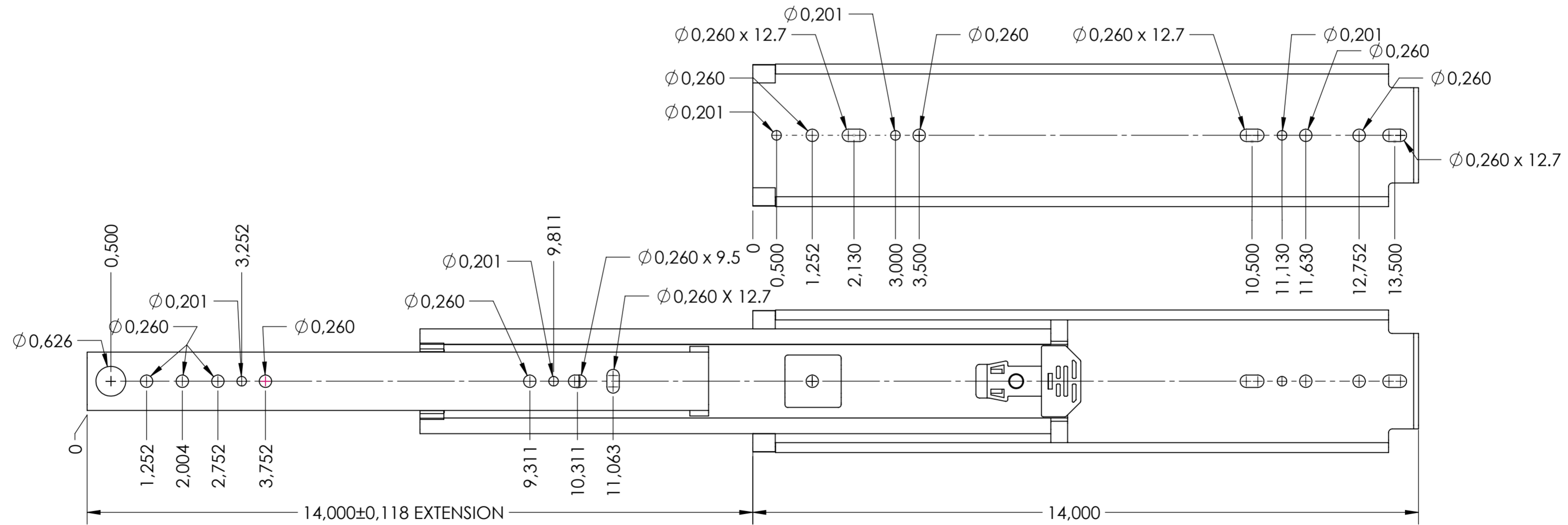

RECOMMENDED HARDWARE:
 CABINET- M6 OR 1/4 BUTTON HEAD SCREWS
 DRAWER- M6 OR 1/4 BUTTON HEAD SCREWS

general tolerances		DIN ISO 128-30 missing dimensions see 3D = theor. intersection	
ISO 2768-m			
This drawing remains our property and may not be multiplied neither be disclosed to third parties (§§1,3 and 5 from the copyright Act (UrhG)) covered according to DIN ISO 16016			
(k)		scale:	surface:
(l)		1:2	
(m)		date	name
(n)		drawn 27-07-2018	HB
(o)		proven 00-00-0000	00
(p)		Fulterer	
(q)			
(r)		Fulterer AG & Co KG A-6890 Lustenau / Austria	
(s)		Fulterer AG CH-9430 St. Margrethen	
(t)	UPDATE TITLE BLOCK	19-03-2019	HB
(u)	changes	date	na.
		drawing number: 5400.14-GA.T018	
		replaces version date:	