

drawn left (right mirrorimage)

dimensions without coating / maximum coating allowed 0.1mm

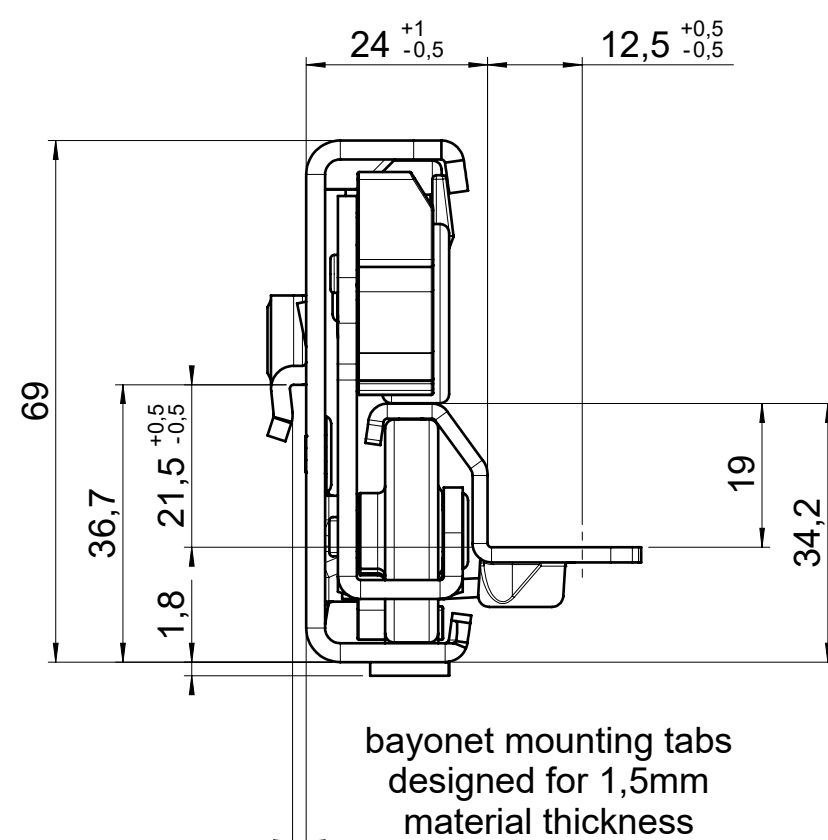
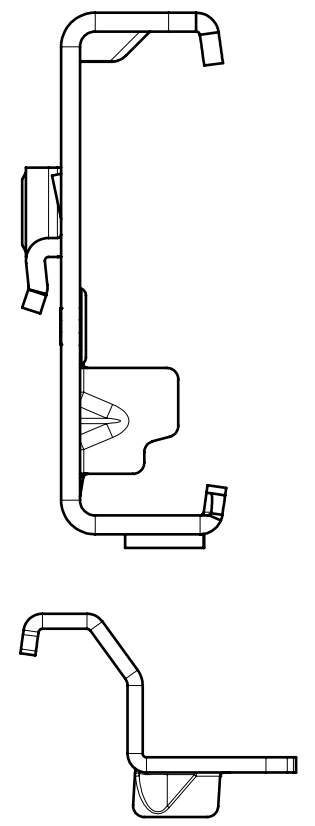
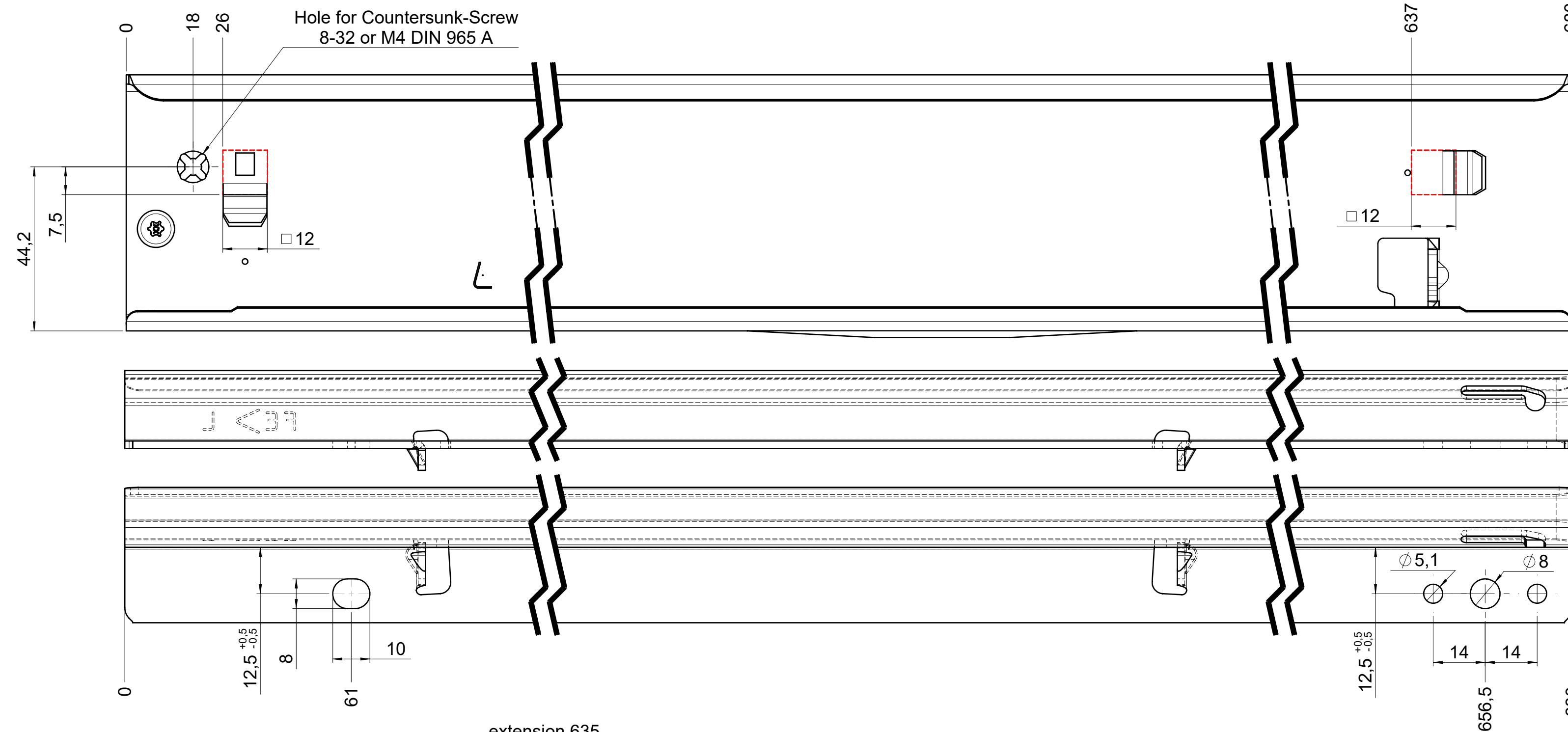

final approval

customer name:

signed by:

date:

all dimensions in mm

DIN ISO 128-30
missing dimensions see 3D
= theor. intersection

This drawing remains our property and may not be multiplied neither be disclosed to third parties (§§1,3 and 5 from the copyright Act (UrhG)) covered according to DIN ISO 16016				scale: 1:1	surface:	material, semi finished parts: steel (technical requirements Fulterer)	A2
(k)				date	name	description: FR 7180 / 65 EN (mm) progressive-action full-extension drawerslide / bottom mount	drawing number: 7180.650-GA.U017 replaces version date:
(l)			drawn 14-12-2022	BM			
(h)			proven 00-00-0000	00			
(g)			Fulterer		Fulterer AG & Co KG A-6890 Lustenau / Austria		
(f)					Fulterer AG CH-9430 St. Margrethen		
(e)			ind.	changes	date	na.	