

drawn left

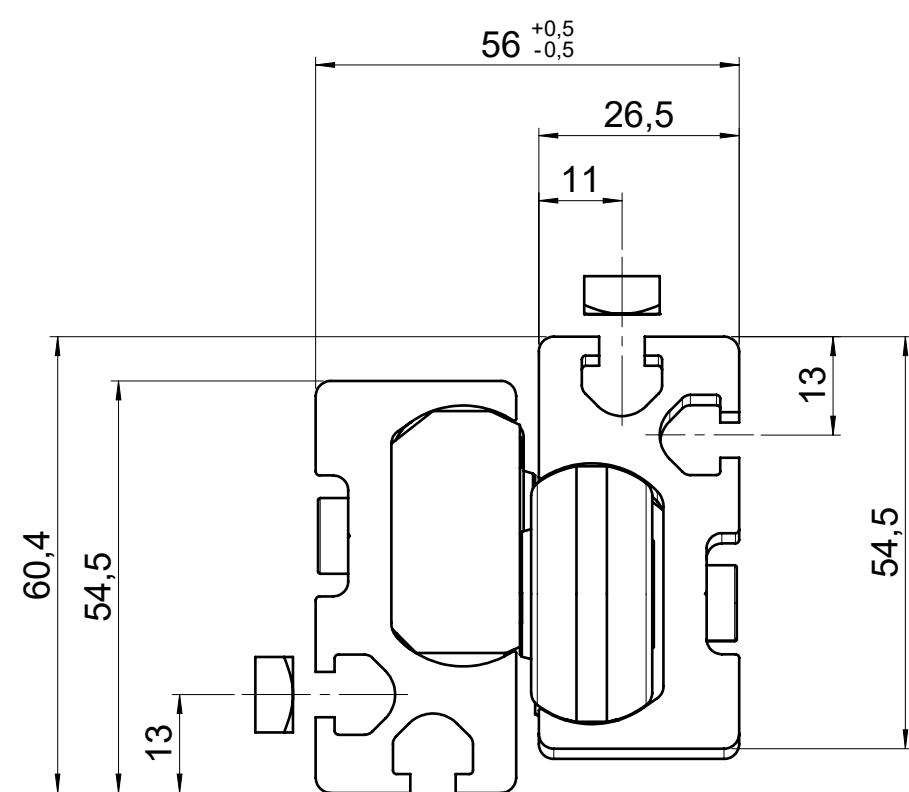
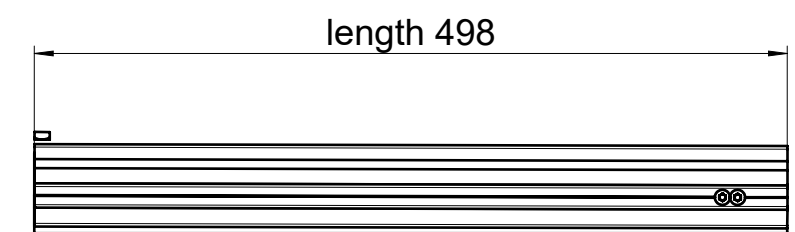
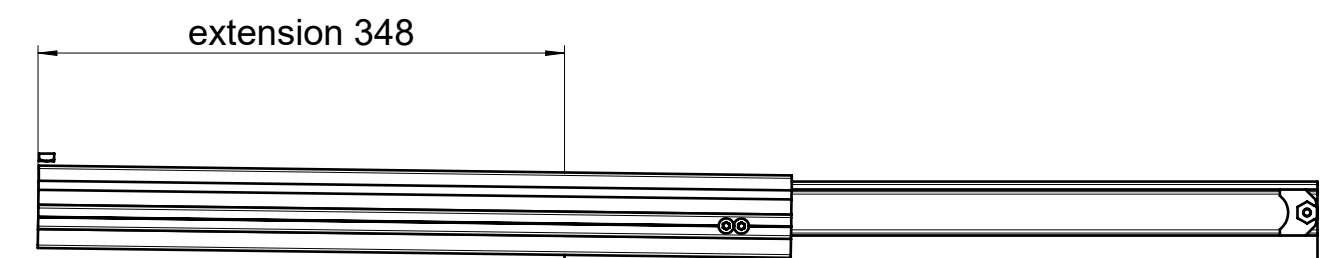
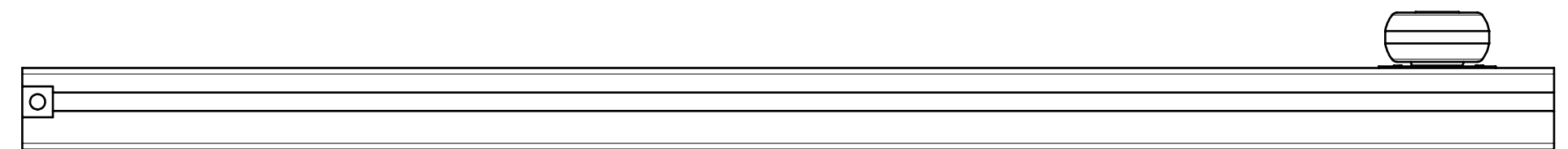
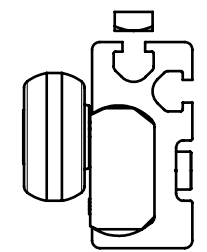
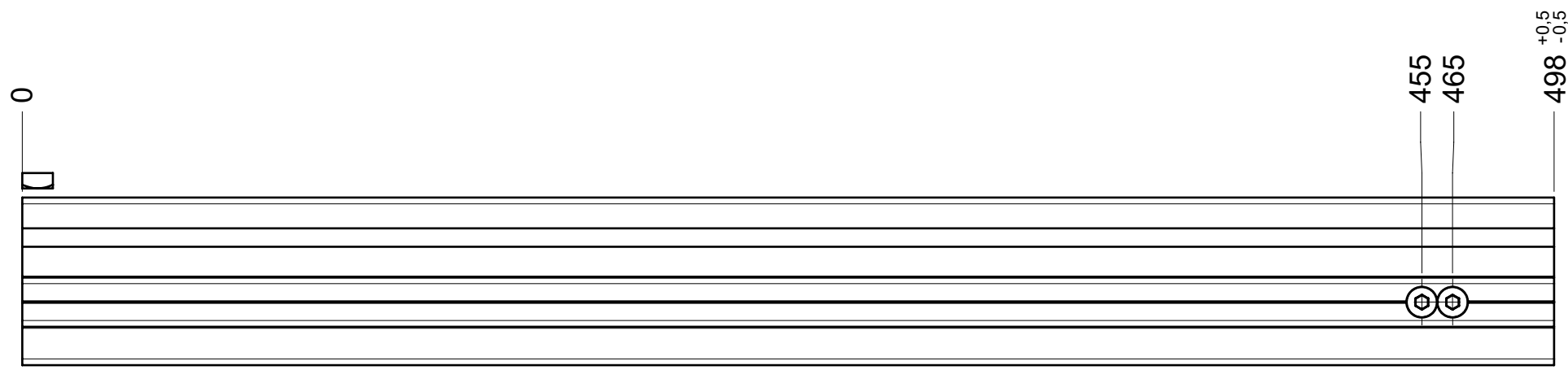
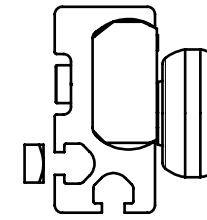

final approval

customer name:

signed by:

date:

all dimensions in mm

DIN ISO 128-30
missing dimensions see 3D
= theor. intersection

This drawing remains our property and may not be multiplied neither be disclosed to third parties (§§1,3 and 5 from the copyright Act (UrhG)) covered according to DIN ISO 16016				scale:	surface:	material, semi finished parts:	A2
(k)				1:2		CS	
(l)						(technical requirements Fulterer)	
(i)				date	name	description: FR 9000 / 50 EN (mm) progressive-action full-extension drawerslide / side mount	
(h)				drawn 01-02-2023	ex		
(g)				proven 01-03-2023	pr		
(f)						drawing number: 9000.500-GA.0000.li	
(e)							
(d)				Fulterer AG & Co KG A-6890 Lustenau / Austria		replaces version date:	
(c)				Fulterer AG CH-9430 St. Margrethen			
(b)				ind.	changes		
(a)					date		
					na.		

drawn right

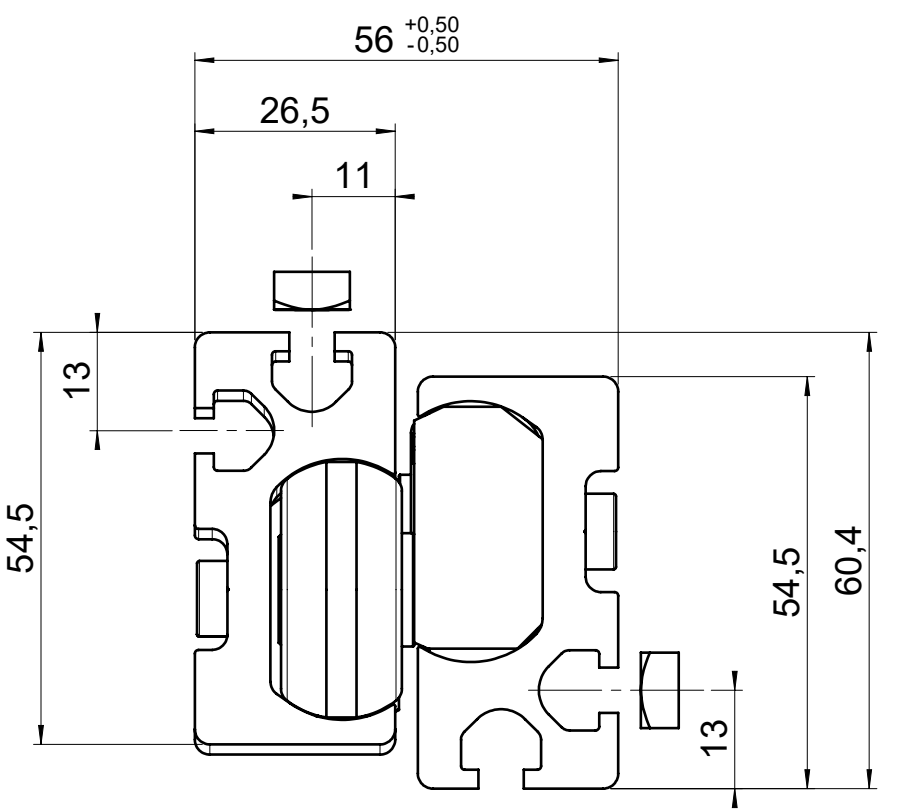
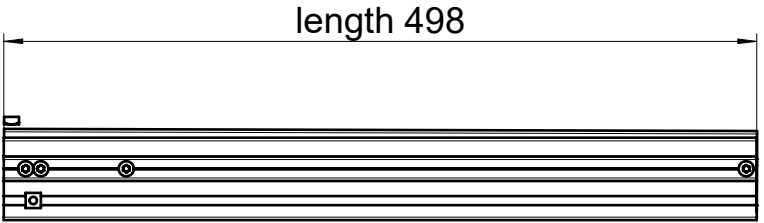
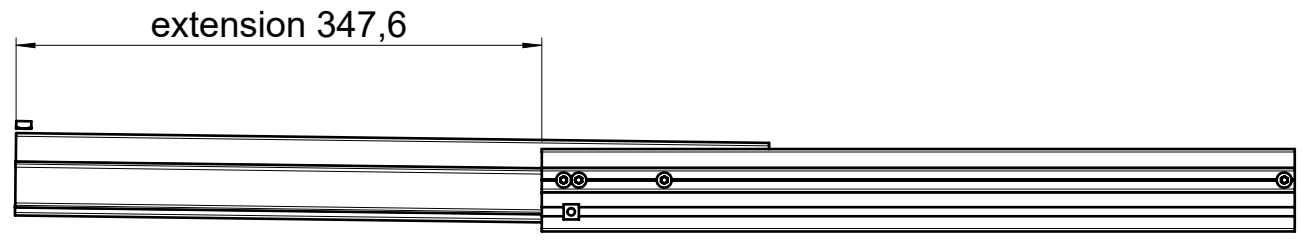
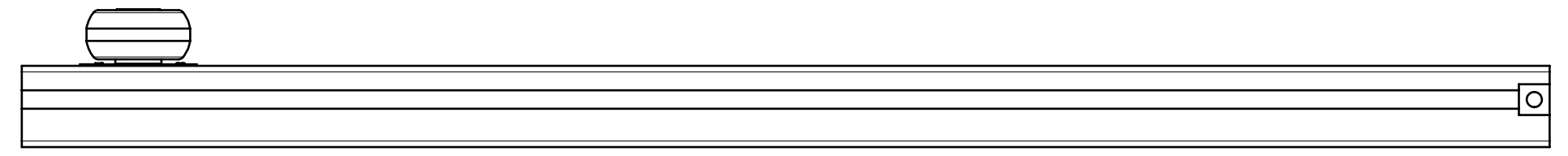
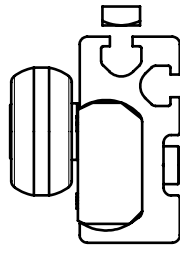
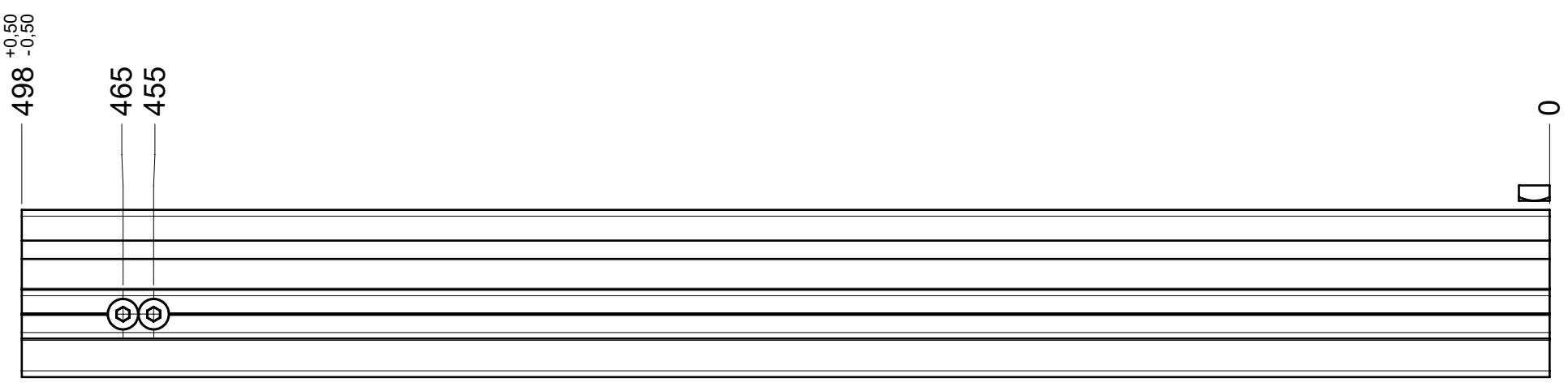
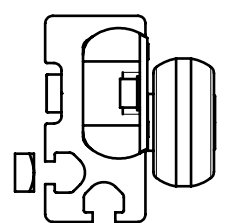
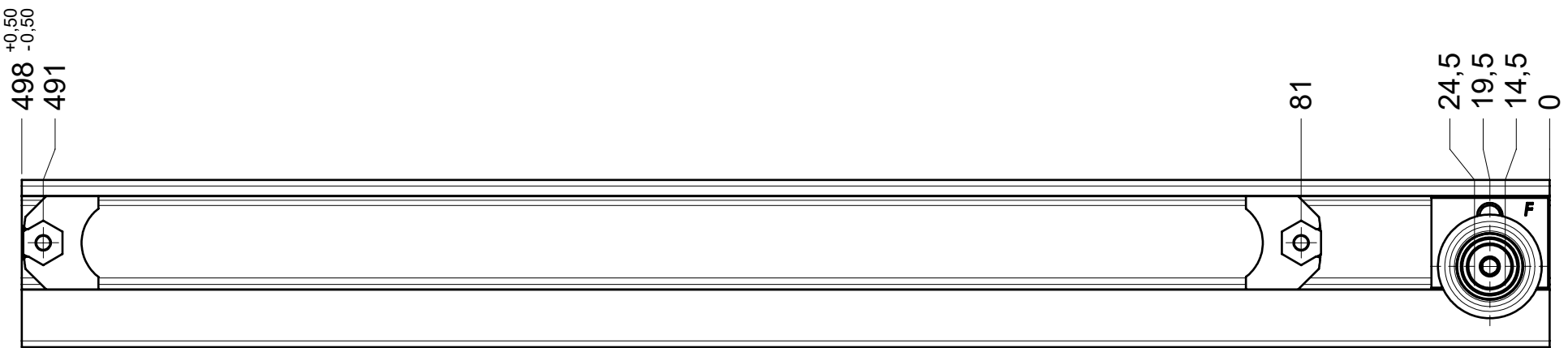

final approval

customer name:

signed by:

date:

all dimensions in mm

DIN ISO 128-30
missing dimensions see 3D
= theor. intersection

This drawing remains our property and may not be multiplied neither be disclosed to third parties (§§1,3 and 5 from the copyright Act (UrhG)) covered according to DIN ISO 16016				scale:	surface:	material, semi finished parts: CS (technical requirements Fulterer)
		1:2				
(k)				date	name	description: FR 9000 / 50 EN (mm) progressive-action full-extension drawerslide / side mount
(l)				drawn 01-02-2023	ex	
(h)				proven 01-03-2023	pr	
(g)						
(f)						drawing number: 9000.500-GA.0000.re replaces version date:
(e)						
(d)						
(c)						
(b)				Fulterer AG & Co KG A-6890 Lustenau / Austria		
(a)				Fulterer AG CH-9430 St. Margrethen		
ind.	changes	date	na.			