

SCALE 1:1

E (1 : 1)

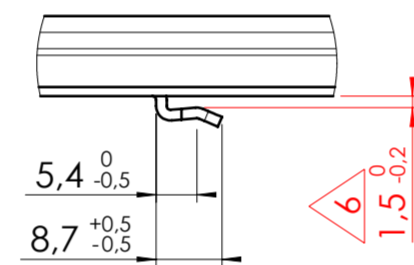

F (1 : 1)

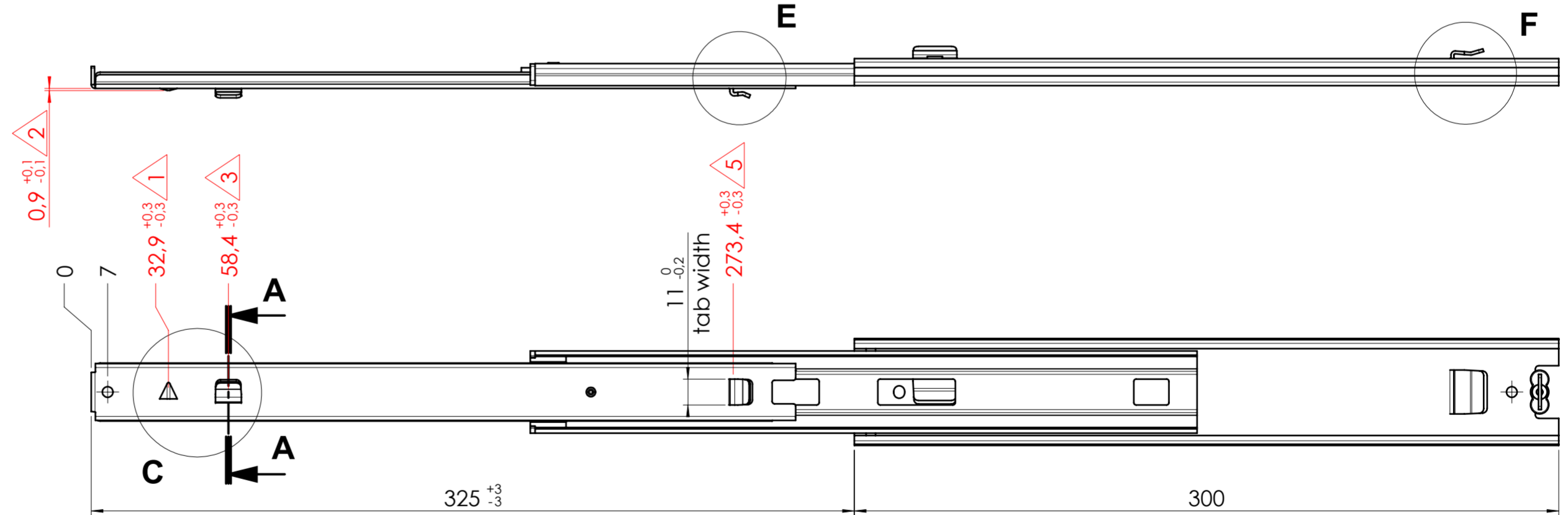
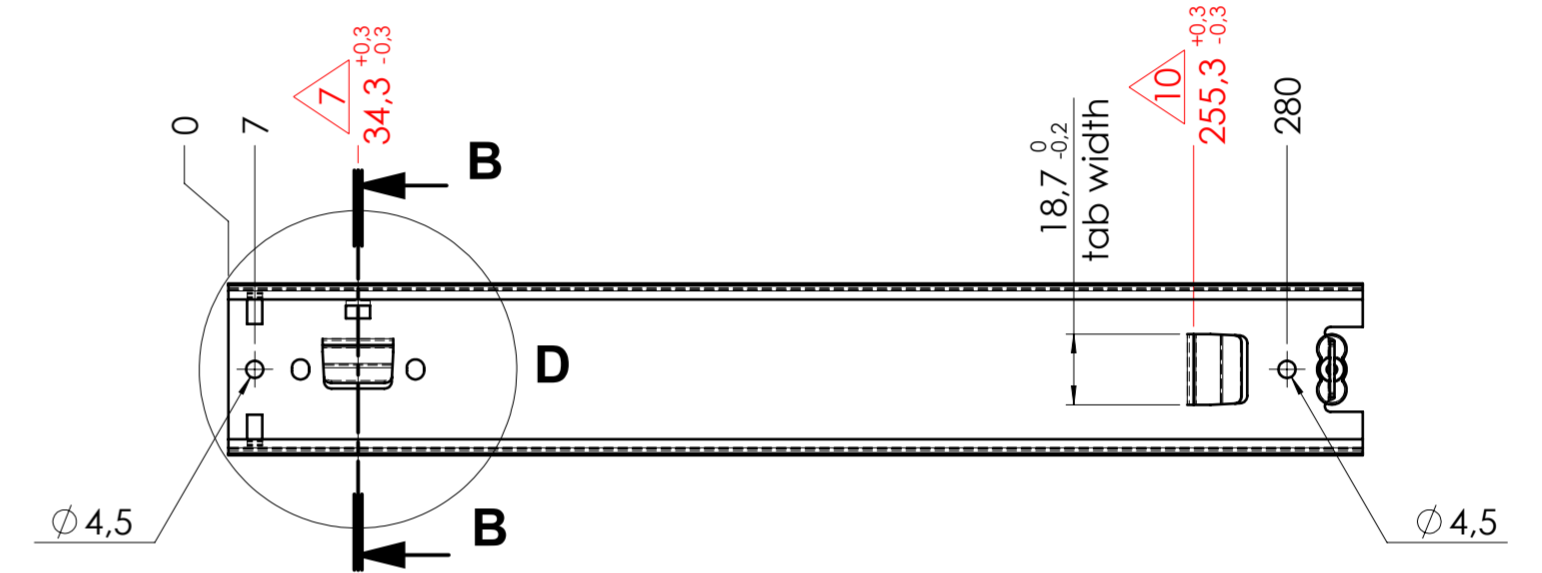
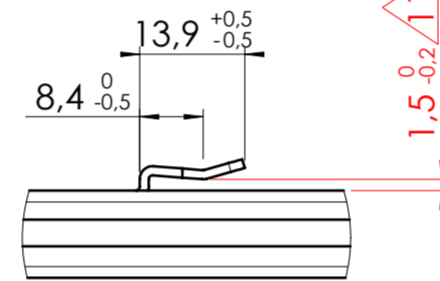

A-A (1 : 1)

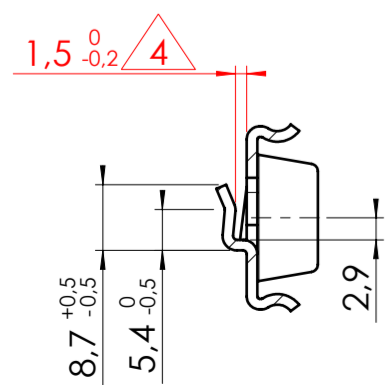

C (1 : 1)

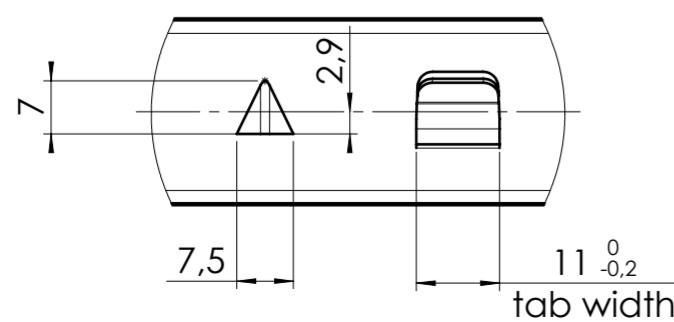

B-B (1 : 1)

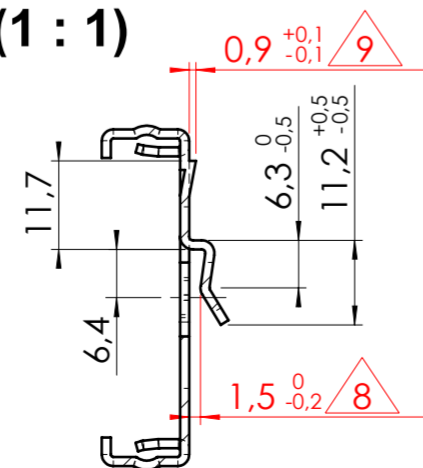

D (1 : 1)

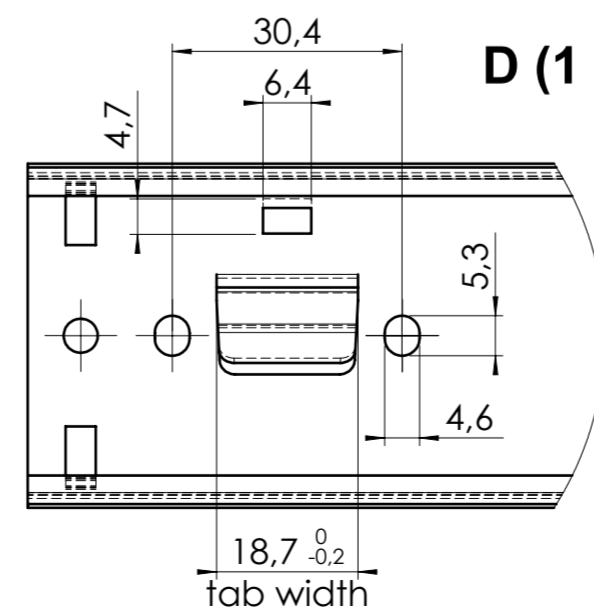

xx = check dimension, next free check number 12

general tolerances		DIN ISO 128-30	
stamping part according Fulterer W18-001	plastic part according DIN ISO 16742 TG4	missing dimensions see 3D	
This drawing remains our property and may not be multiplied neither be disclosed to third parties (§§1,3 and 5 from the copyright Act (UrhG))		= theor. intersection	
covered according to DIN ISO 16016		scale: 1:2	surface: A2
		date 22-04-2022	name CS
		proven 00-00-0000	00
		material, semi finished parts: STEEL (technical requirements Fulterer)	
		description: SIDE MOUNT OVER EXTENSION SMT (1,5) DRAWER SLIDE WITH DRAWER DISCONNECT	
		drawing number: 5046.300-GA.C103A	
		replaces version date:	
ind.	changes	date	na.