

5210.600-GA.T107

X

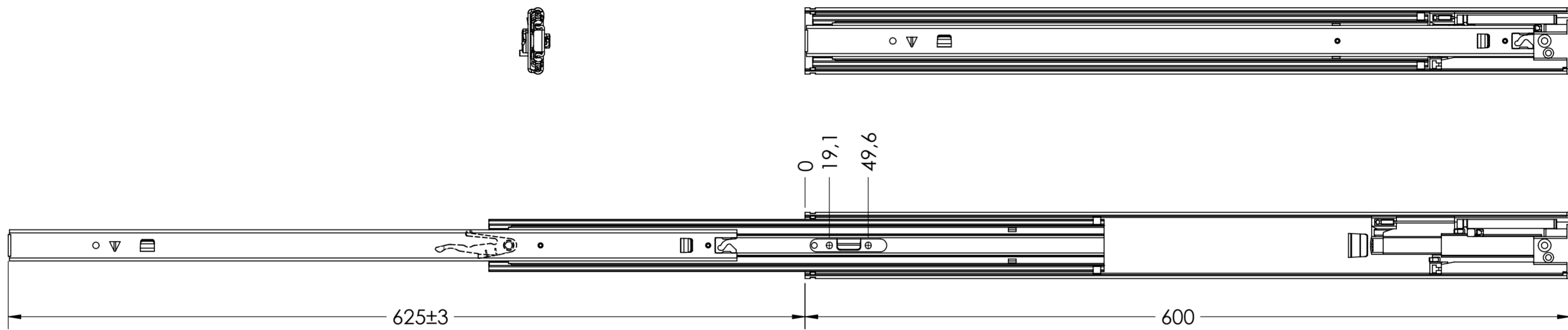
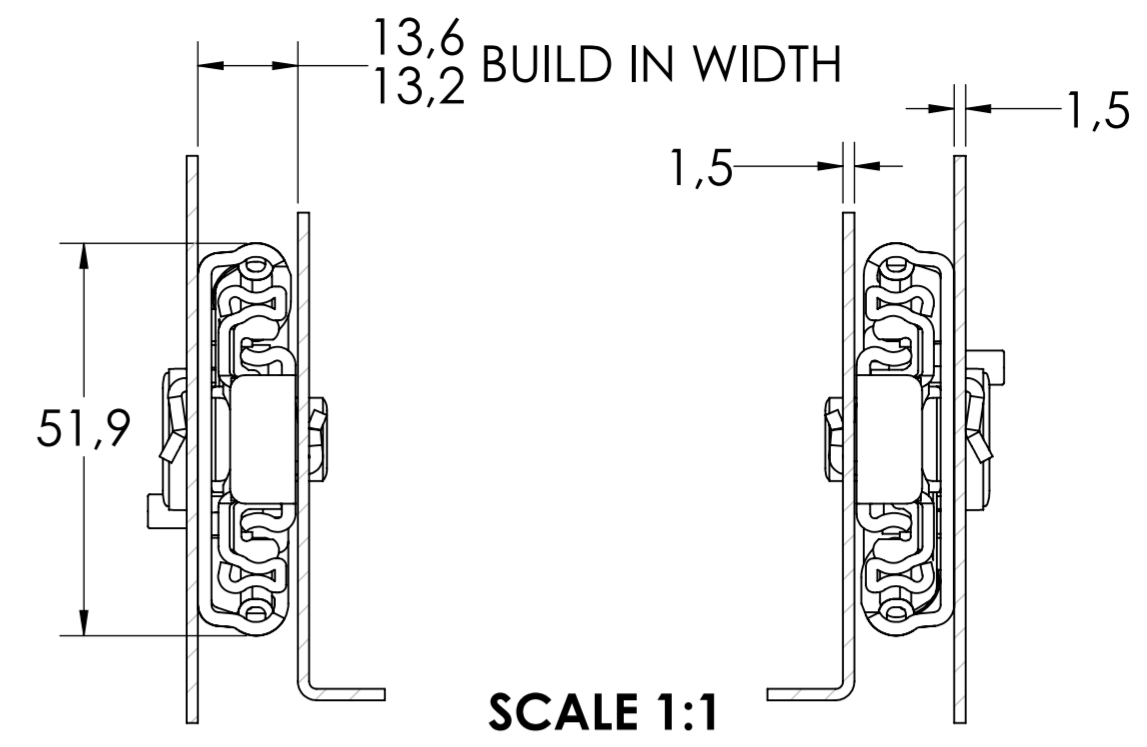

DRAWER MOUNTING CUTOUTS

CABINET MOUNTING CUTOUTS

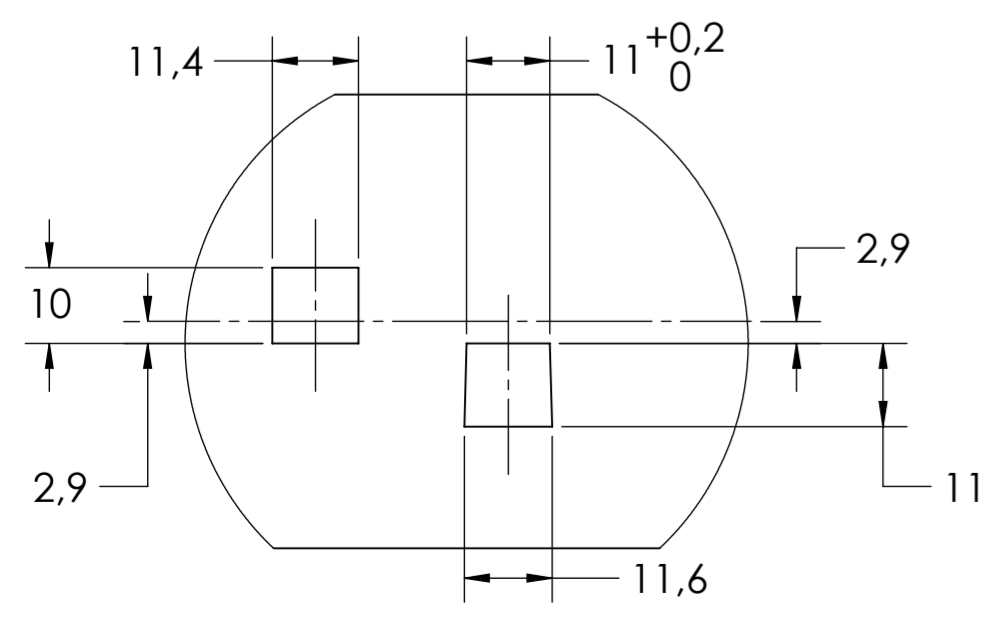
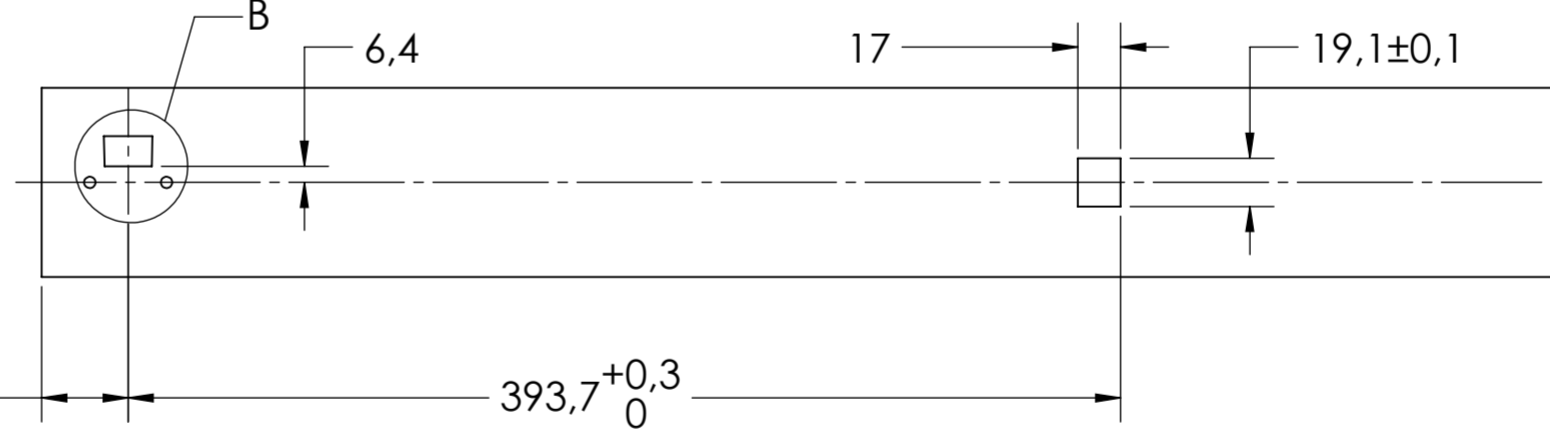
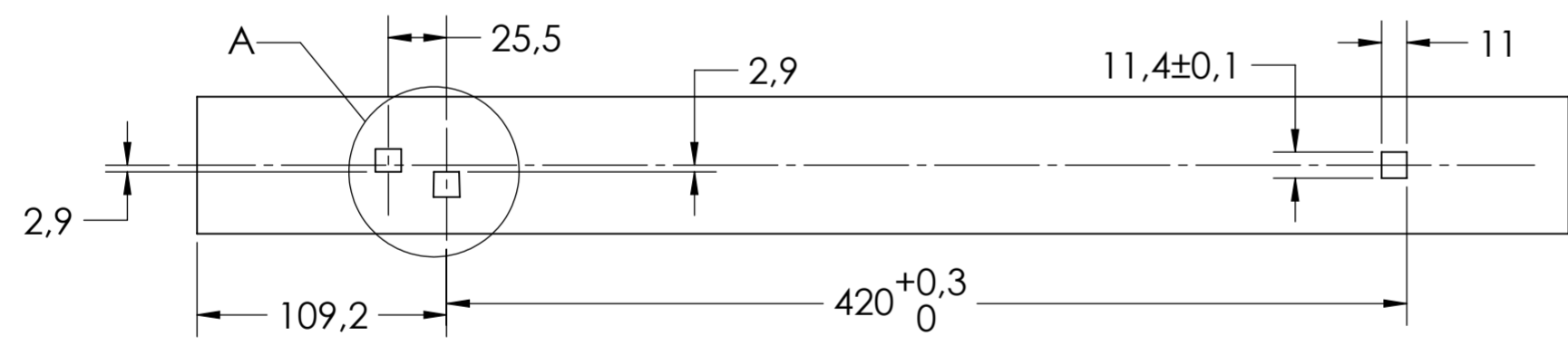

DETAIL A
SCALE 1:1

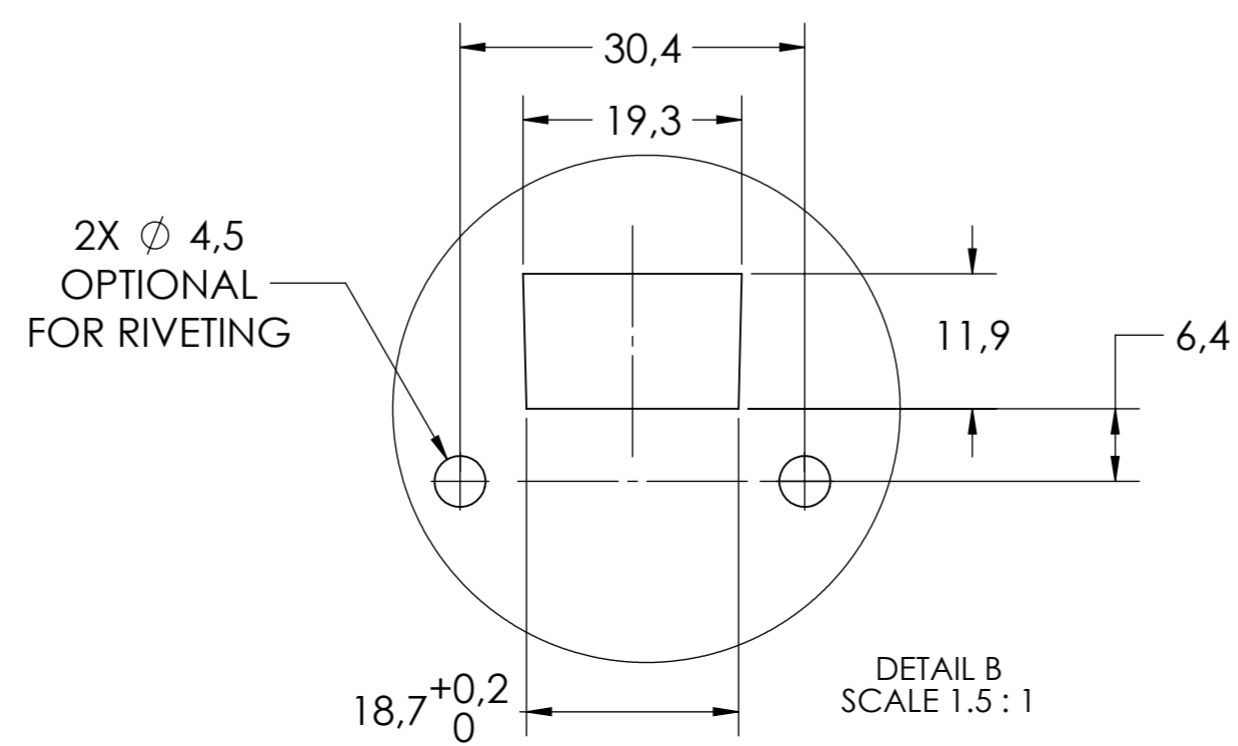

DETAIL B
SCALE 1.5:1

PULL OUT FORCE: 24N ± 2N (5.4 lbf. ± 0.5 lbf.)

general tolerances		DIN ISO 128-30 missing dimensions see 3D = theor. intersection	
ISO 2768-m			
This drawing remains our property and may not be multiplied neither be disclosed to third parties (§§1,3 and 5 from the copyright Act (UrhG)) covered according to DIN ISO 16016			
(k)	scale:	1:3	surface:
(l)	date	29-05-2019	name
(m)	drawn	HB	
(n)	proven	00-00-0000	00
(o)	Fulterer		material, semi finished parts:
(p)			STEEL
(q)	Fulterer AG & Co KG A-6890 Lustenau / Austria		(technical requirements Fulterer)
(r)			description:
(s)	Fulterer AG CH-9430 St. Margrethen		SIDE MOUNT OVER EXTENSION SMT (1.5) SLIDE WITH SOFT CLOSE & DRAWER DISCONNECT
(t)			drawing number:
(u)	00-00-0000 0		5210.600-GA.T107
(v)			replaces version date:
(w)	changes	date	na.