

SCALE 1:1

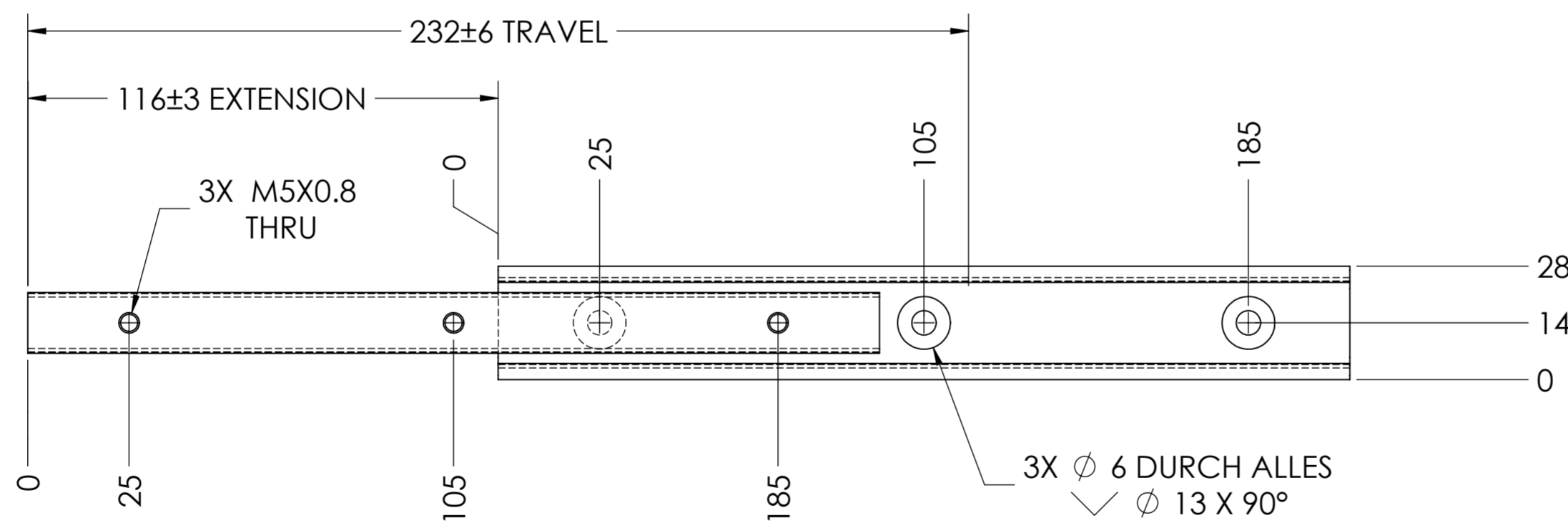
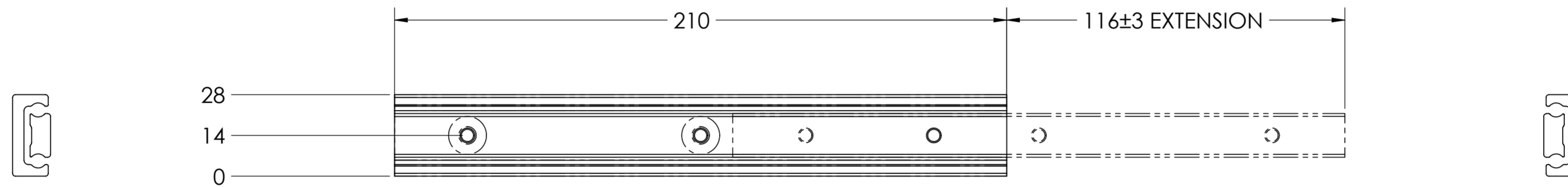

RECOMMENDED HARDWARE:
 CABINET- M5 FLAT HEAD SCREWS
 DRAWER- M5 x .8 SCREWS

X

general tolerances		DIN ISO 128-30 missing dimensions see 3D = theor. intersection	
ISO 2768-m			
This drawing remains our property and may not be multiplied neither be disclosed to third parties (§§1,3 and 5 from the copyright Act (UrhG)) covered according to DIN ISO 16016			
scale: 3:43:4		surface: A2	
date: 23-07-2018		name: HB	
drawn: 23-07-2018		proven: 00-00-0000 00	
proven: 00-00-0000		00	
Fulterer		description: TWO-WAY TRAVEL SIDE MOUNT TWO-WAY TRAVEL SIDE MOUNT SUPER HEAVY DUTY SLIDE	
Fulterer AG & Co KG A-6890 Lustenau / Austria		drawing number: 5328.210-GA.T091	
Fulterer AG CH-9430 St. Margrethen		replaces version date:	
ind.	changes	date	na.