

SCALE 1:1

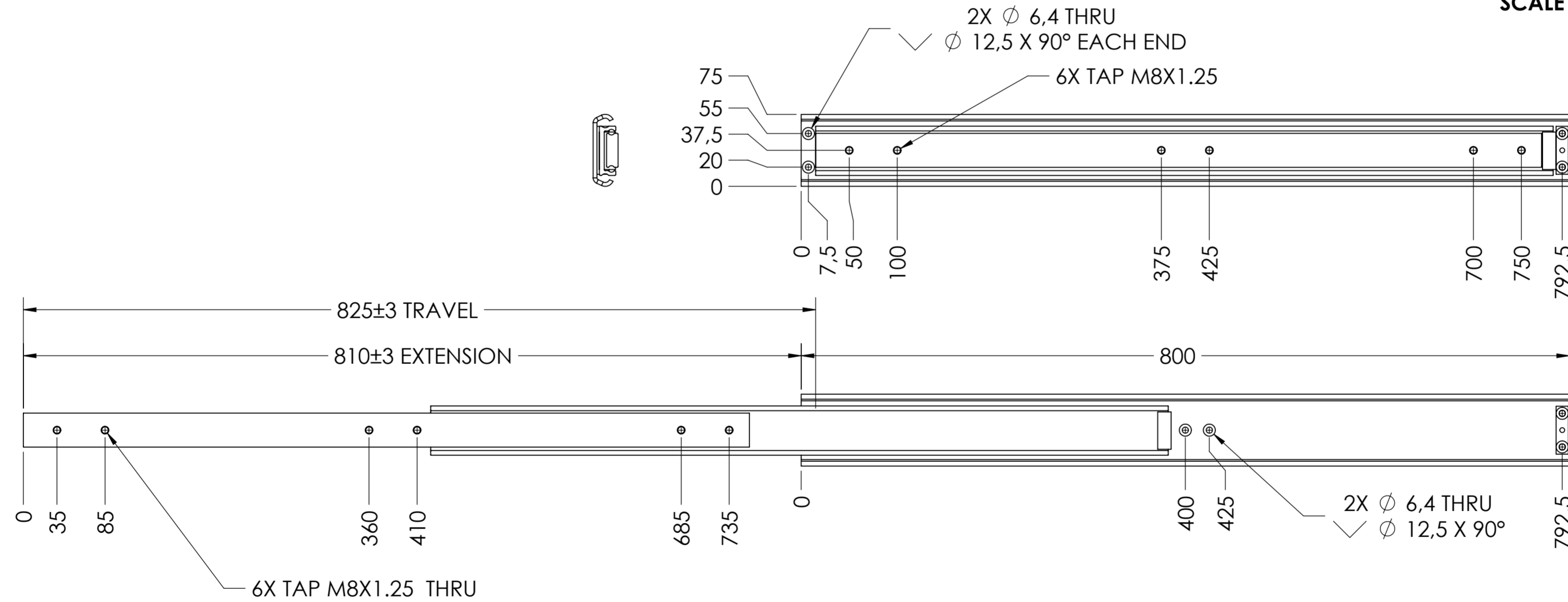

RECOMMENDED HARDWARE:
CABINET- M6 FLATHEAD SCREWS

DRAWER- M8x1.25 SCREWS

general tolerances		DIN ISO 128-30 missing dimensions see 3D = theor. intersection	
ISO 2768-m			
This drawing remains our property and may not be multiplied neither be disclosed to third parties (§§1,3 and 5 from the copyright Act (UrhG)) covered according to DIN ISO 16016			
(k)		scale:	surface:
(l)		1:4	
(m)		date	name
(n)		drawn 20-07-2018	HB
(o)		proven 00-00-0000	00
(p)		Fulterer	
(q)		Fulterer AG & Co KG A-6890 Lustenau / Austria	
(r)		Fulterer AG CH-9430 St. Margrethen	
(s)		drawing number: 5426.800-GA.T092	
(t)		replaces version date:	
(u)	0	00-00-0000	0
(v)	ind.	changes	date na.