

DETAIL A
SCALE 2:1

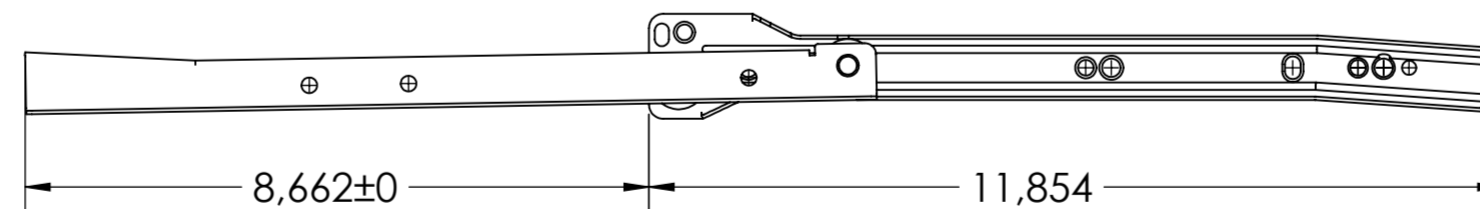
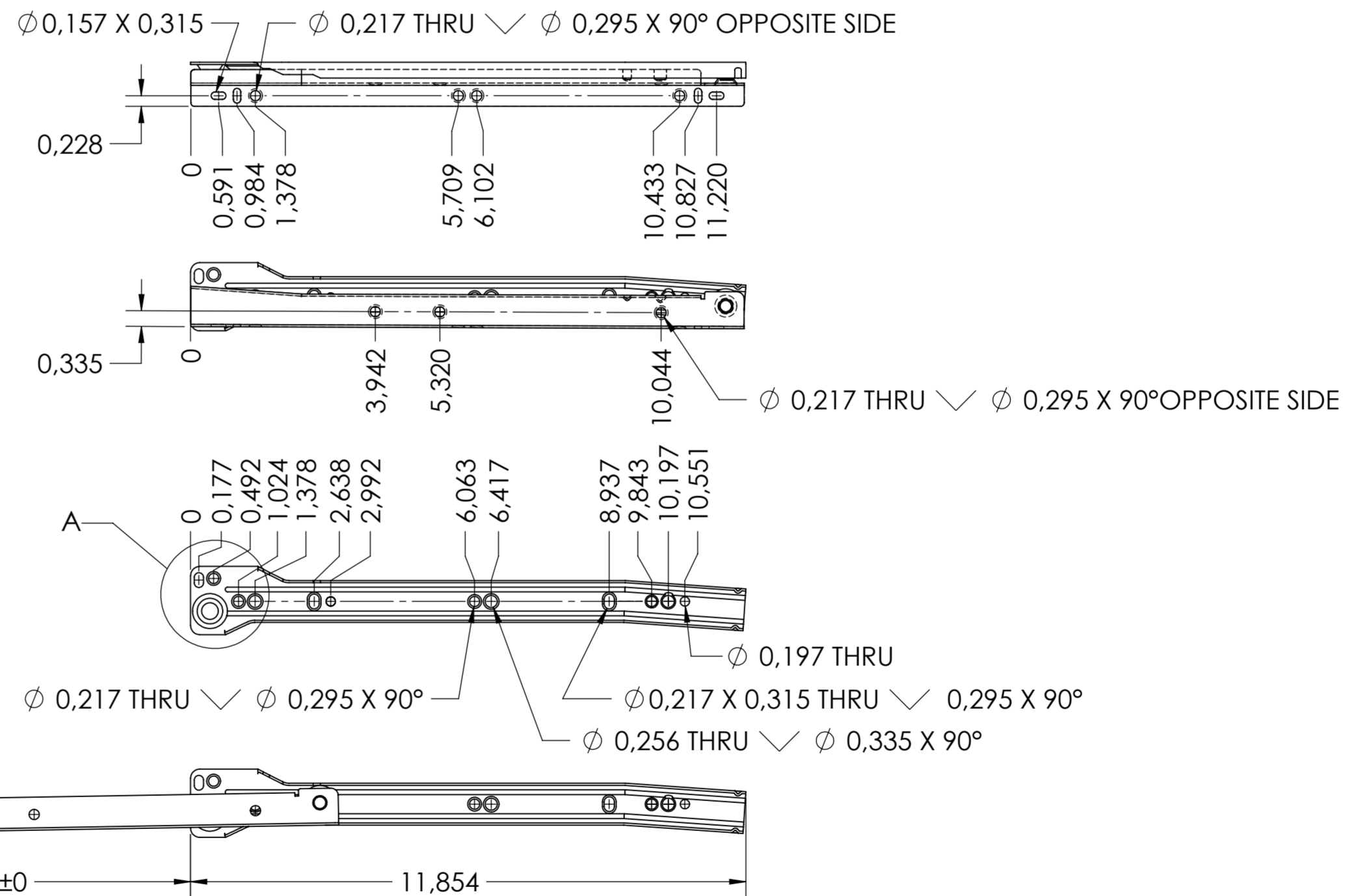

RECOMMENDED HARDWARE

- CABINET- M4 FLAT HEAD SCREW OR M6 EURO SCREW (#8 FLAT HEAD SCREW OR #6 FLAT HEAD SCREW)
- DRAWER- M3 FLAT HEAD SCREW (#6 FLAT HEAD SCREW)

general tolerances		DIN ISO 128-30 missing dimensions see 3D = theor. intersection	
ISO 2768-m			
This drawing remains our property and may not be multiplied neither be disclosed to third parties (§§1,3 and 5 from the copyright Act (UrhG))			
covered according to DIN ISO 16016		scale:	surface:
(k)		3:8	
(l)		date	name
(m)		drawn 09-07-2019	HB
(n)		proven 00-00-0000	00
(o)		Fulterer	
(p)			
(q)		Fulterer AG & Co KG A-6890 Lustenau / Austria	
(r)		Fulterer AG CH-9430 St. Margrethen	
(s)		drawing number: 1921.300-GA.C022	
(t)		replaces version date:	
(u)			
(v)			
(w)			
(x)			
(y)			
(z)			
ind.	changes	date	na.