

SCALE 1:1

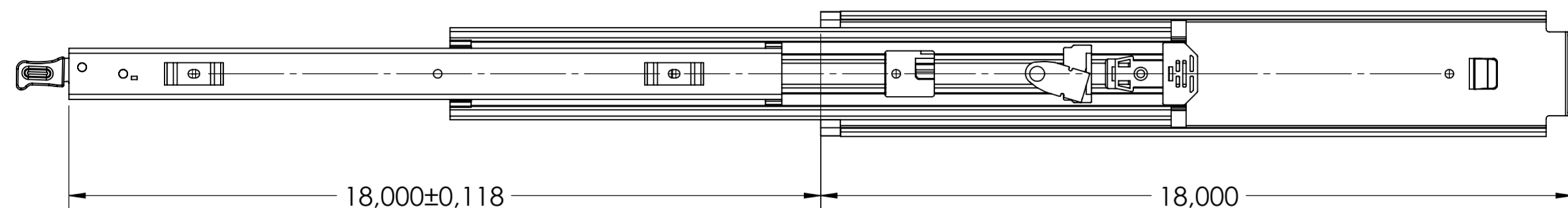

**DRAWER MOUNTING CUTOUTS**

**CABINET MOUNTING CUTOUTS**

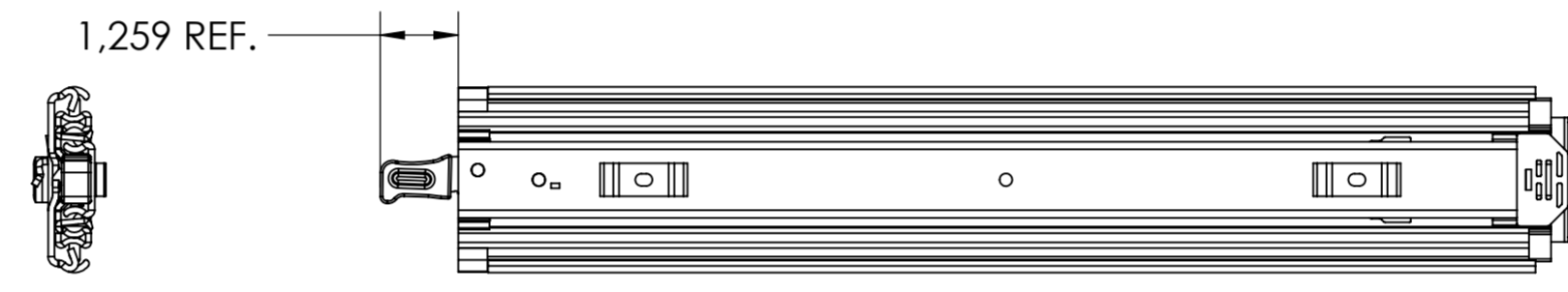
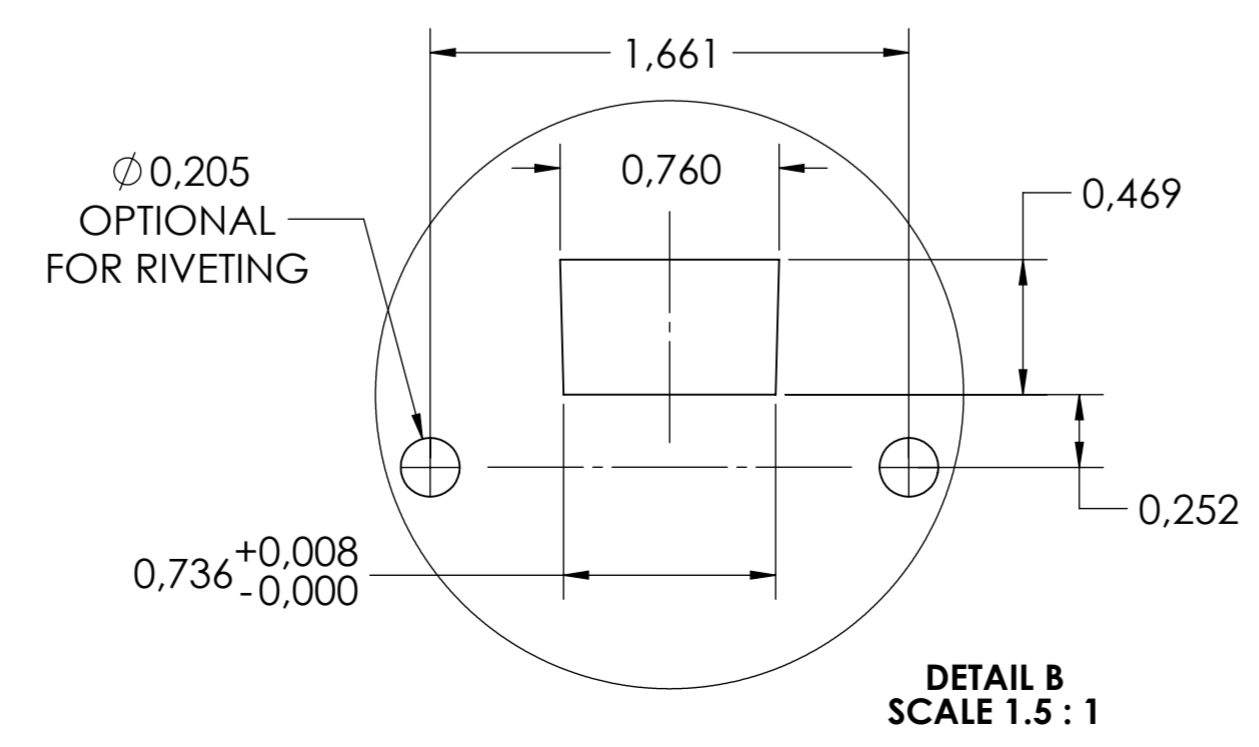
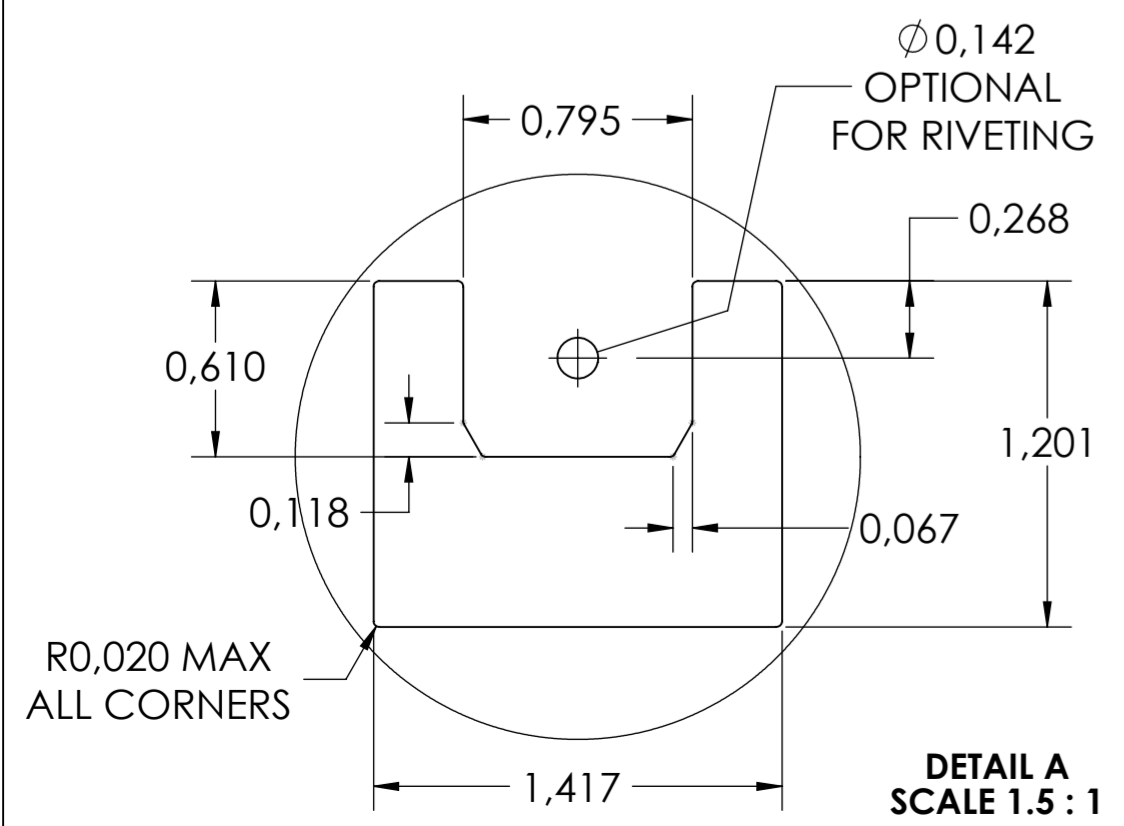
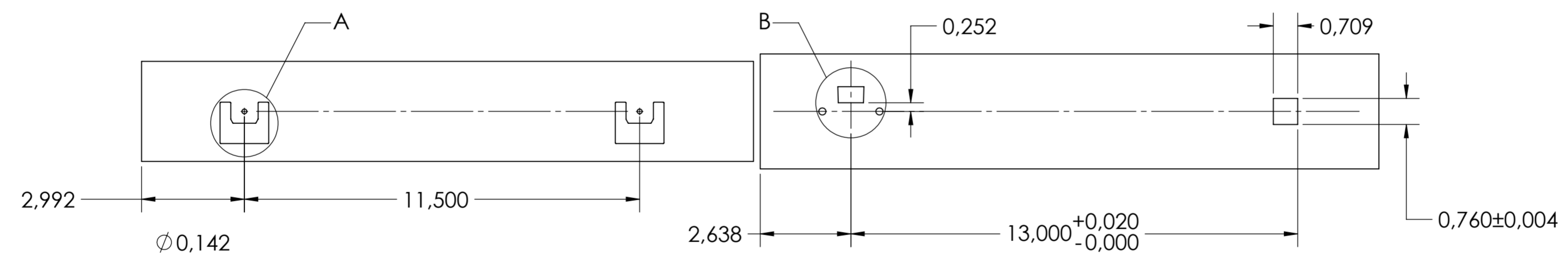

general tolerances		DIN ISO 128-30 missing dimensions see 3D = theor. intersection	
ISO 2768-m			
This drawing remains our property and may not be multiplied neither be disclosed to third parties (§§1,3 and 5 from the copyright Act (UrhG))			
covered according to DIN ISO 16016		scale: 1:3	surface: A2
(k)		date	name
(l)		drawn 24-07-2019	HB
(m)		proven 00-00-0000	00
(n)		<b>Fulterer</b>	
(o)			
(p)		Fulterer AG & Co KG A-6890 Lustenau / Austria	
(q)		Fulterer AG CH-9430 St. Margrethen	
(r)		drawing number: <b>5400.18-GA.T118</b>	
(s)		replaces version date:	
(t)		ind. changes	date na.