

SCALE 1:1

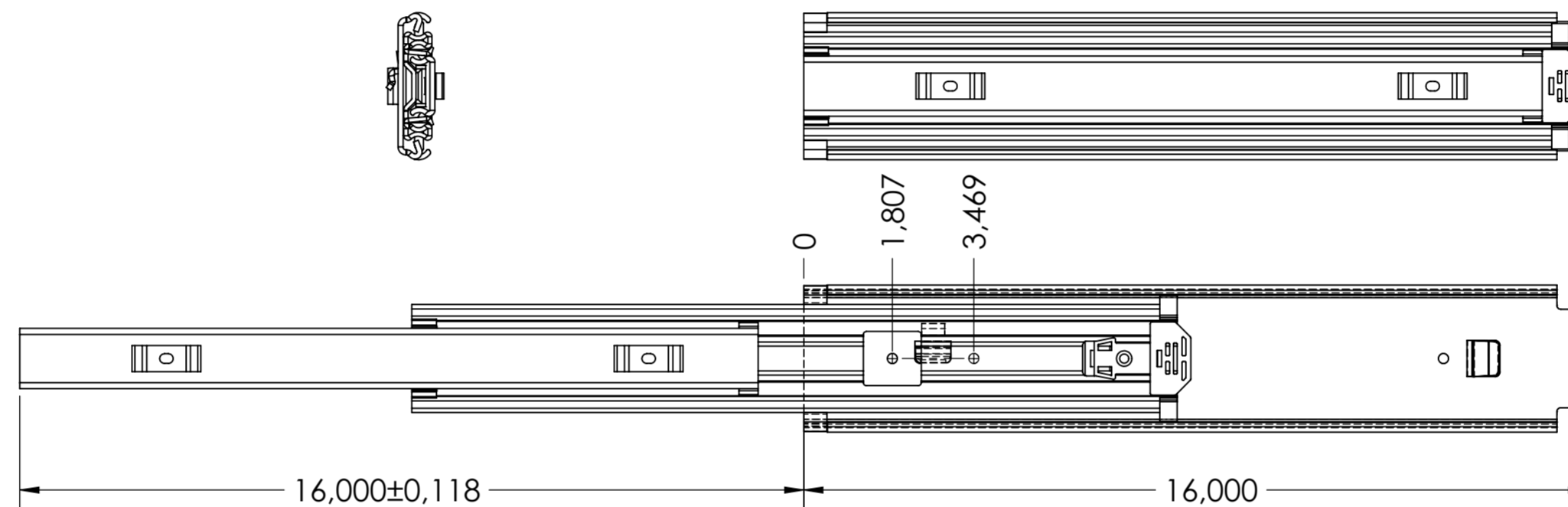

DRAWER MOUNTING CUTOUTS

CABINET MOUNTING CUTOUTS

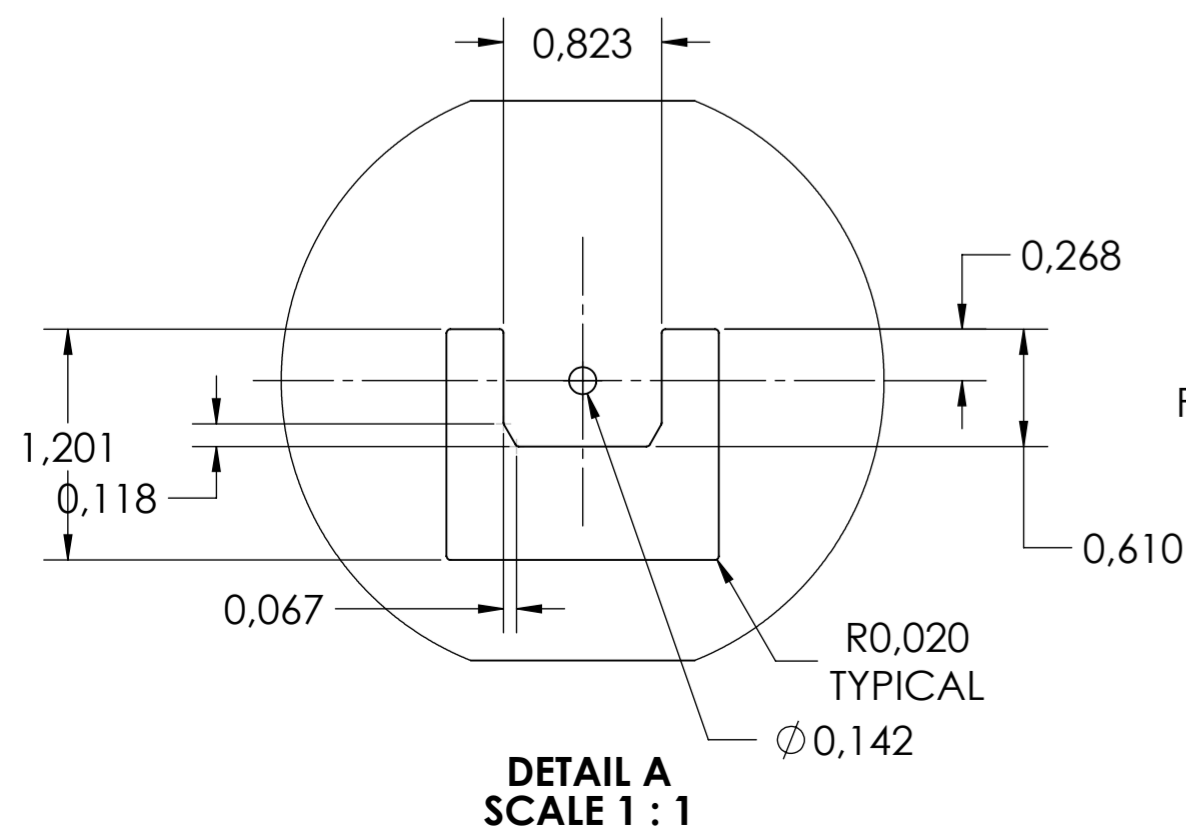
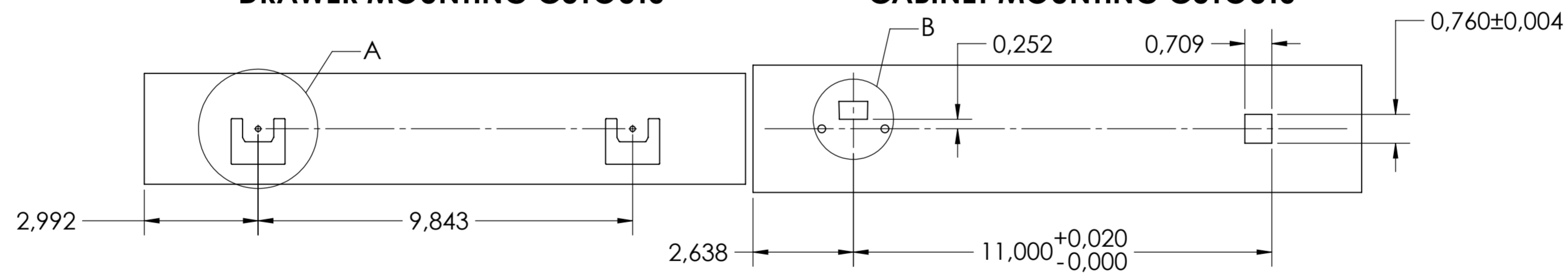

DETAIL A  
SCALE 1:1

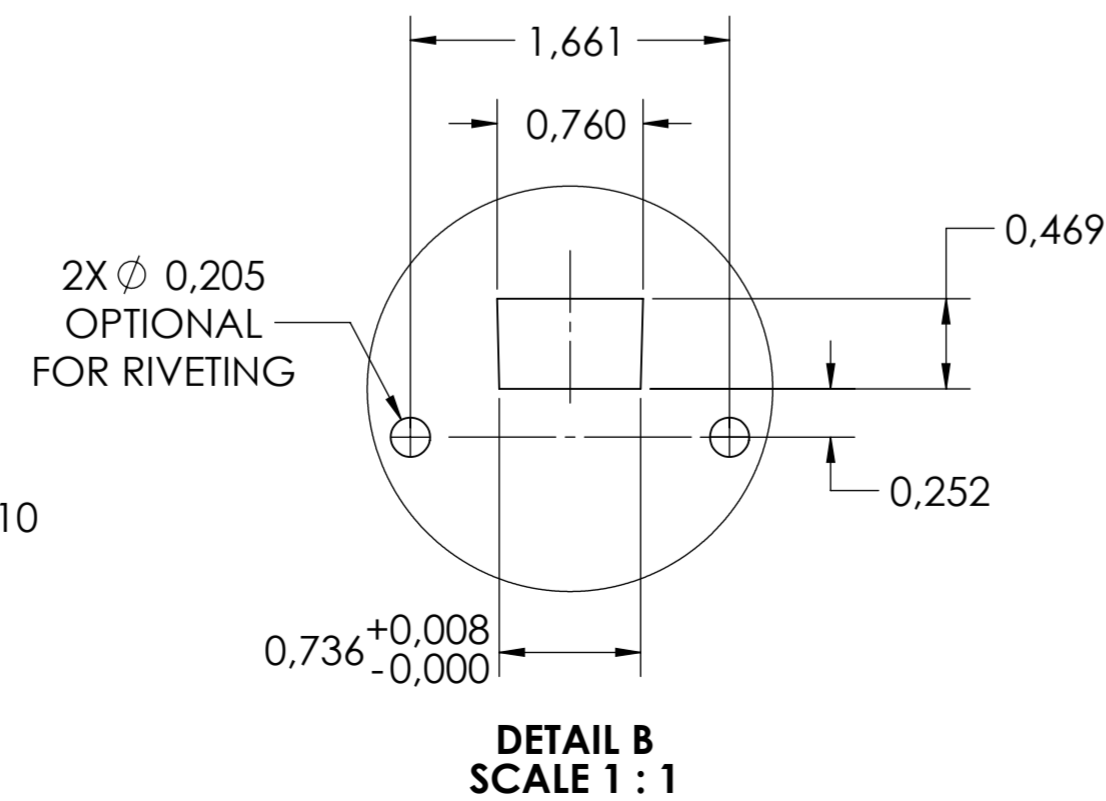

DETAIL B  
SCALE 1:1

general tolerances		DIN ISO 128-30 missing dimensions see 3D = theor. intersection	
ISO 2768-m			
This drawing remains our property and may not be multiplied neither be disclosed to third parties (§§1,3 and 5 from the copyright Act (UrhG))			
covered according to DIN ISO 16016		scale:	surface:
		1:3	
(k)		date	name
(l)		drawn 30-07-2019	HB
(m)		proven 00-00-0000	00
(n)		<b>Fulterer</b>	
(o)			
(p)		Fulterer AG & Co KG	
(q)		A-6890 Lustenau / Austria	
(r)		Fulterer AG	
(s)		CH-9430 St. Margrethen	
(t)		drawing number:	
(u)		5400.16-GA.T114	
(v)		replaces version date:	
(w)			
(x)			
(y)			
(z)			
ind.	changes	date	na.