

drawn left (right mirrorimage)

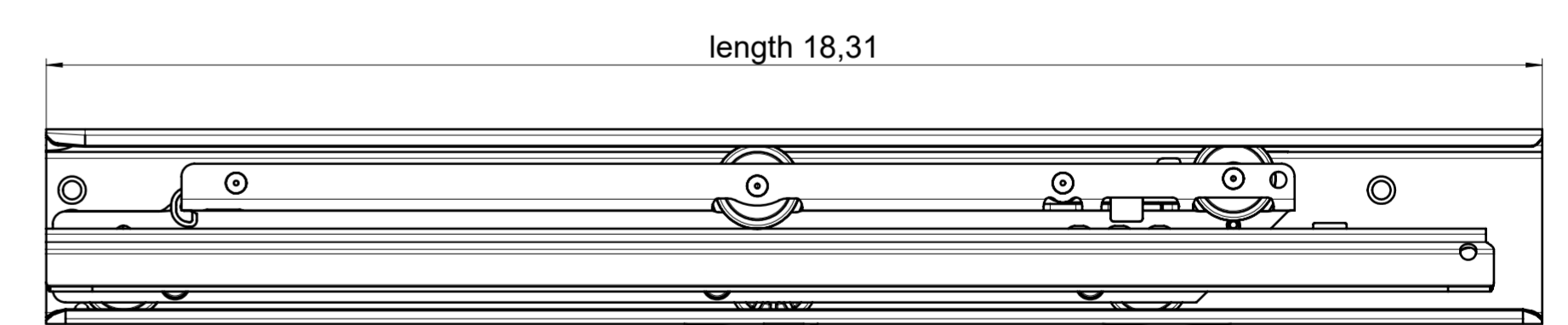
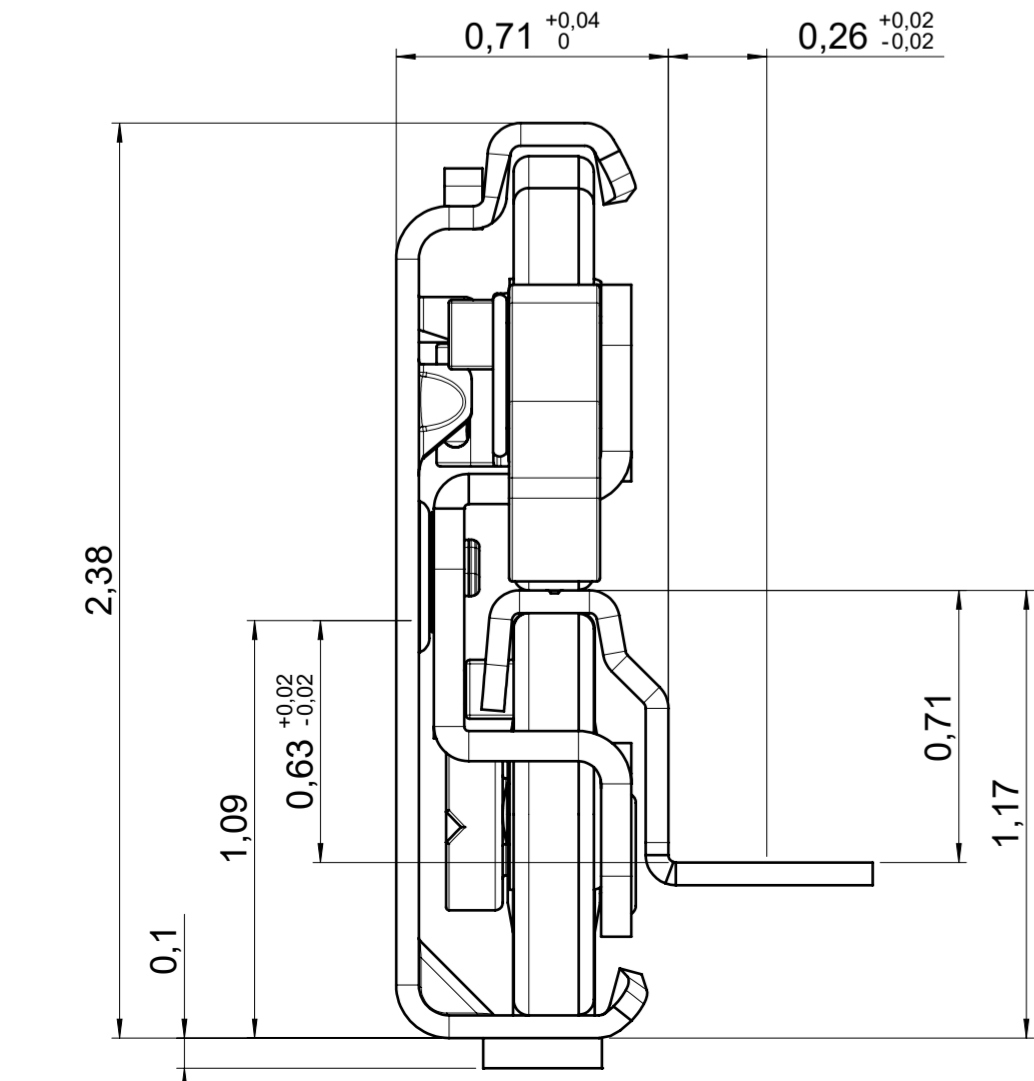
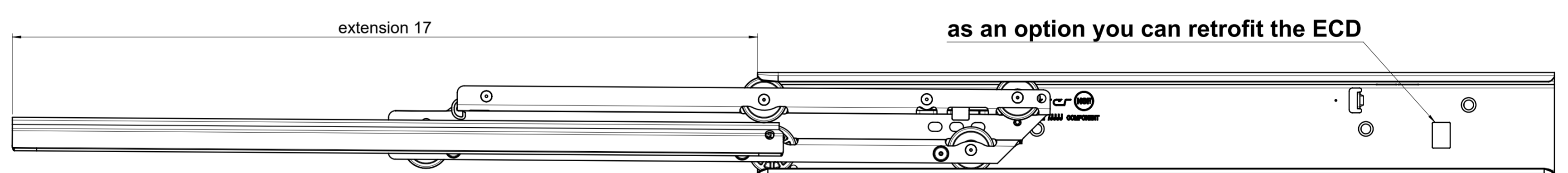
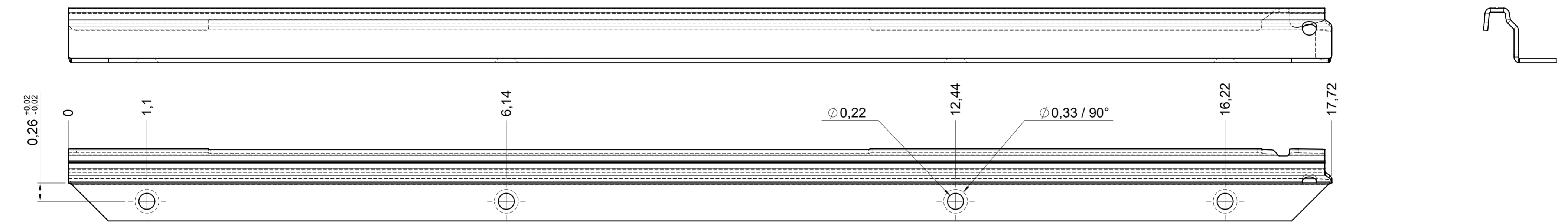
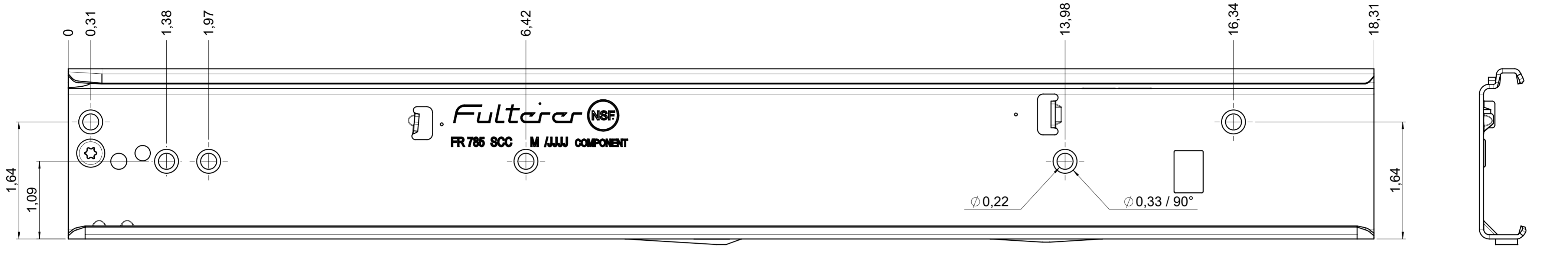

final approval

customer name:

signed by:

date:

all dimensions in inch				DIN ISO 128-30 missing dimensions see 3D = theor. intersection	
This drawing remains our property and may not be multiplied neither be disclosed to third parties (§§1,3 and 5 from the copyright Act (UrhG)) covered according to DIN ISO 16016					
scale: 1:1		surface:		material, semi finished parts: CS (technical requirements Fulterer)	
drawn 17-01-2023		date 17-01-2023		name ex	
proven 01-02-2023		date 01-02-2023		name pr	
Fulterer				description: FR 786 / 45 CS EN (inch) progressive-action full-extension drawerslide / bottom mount	
Fulterer AG & Co KG A-6890 Lustenau / Austria				drawing number: CS# 786.450-GA.L501	
Fulterer AG CH-9430 St. Margrethen				replaces version date:	
ind.	changes	date	na.		