

drawn left

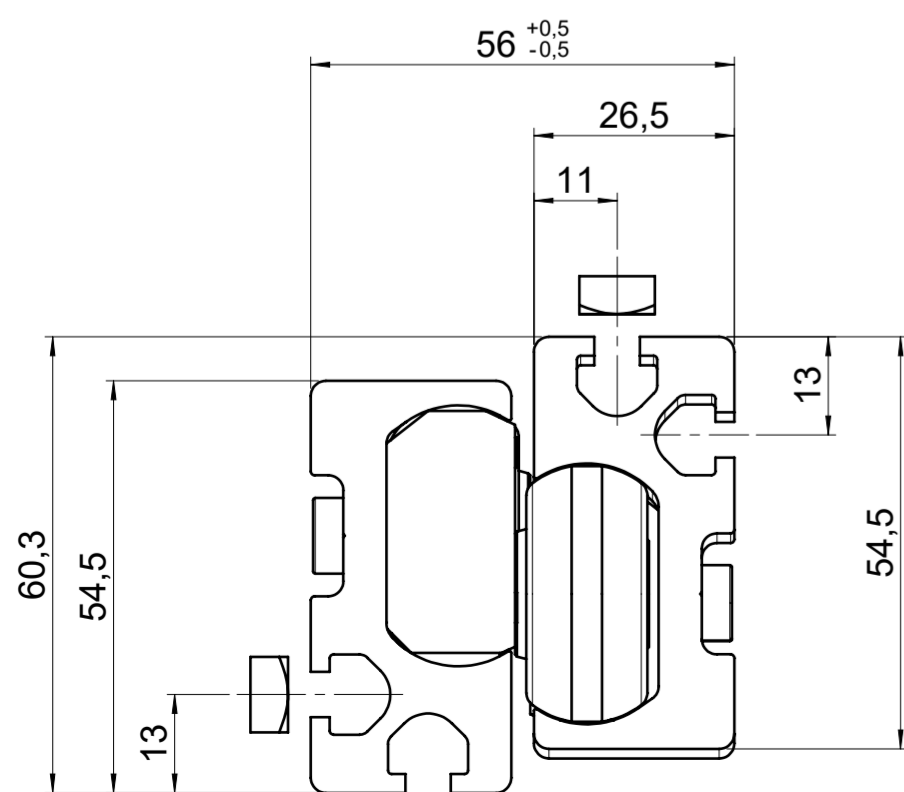
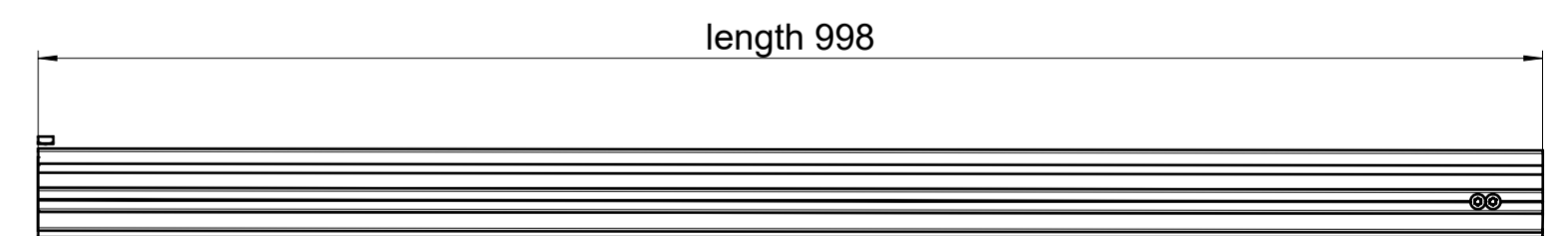
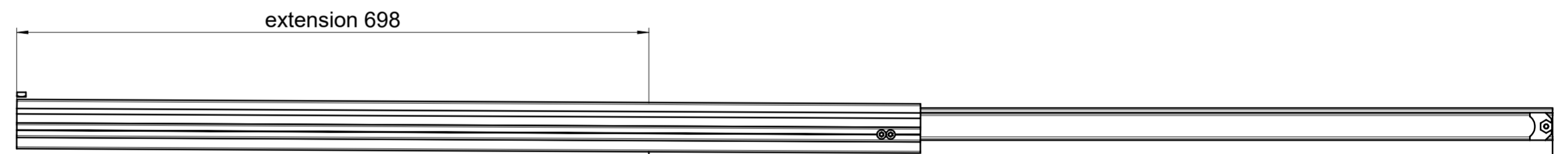
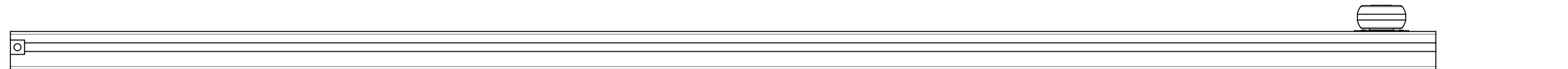
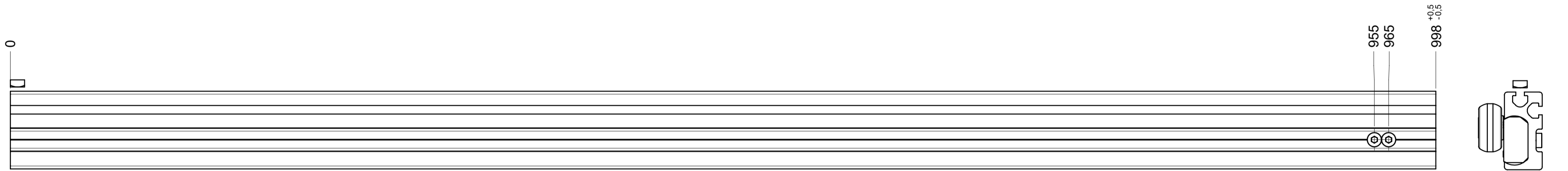

final approval

customer name:

signed by:

date:

all dimensions in mm

DIN ISO 128-30
missing dimensions see 3D
= theor. intersection

This drawing remains our property and may not be multiplied neither be disclosed to third parties (§§1,3 and 5 from the copyright Act (UrhG)) covered according to DIN ISO 16016

(k) (l) (i) (h) (g) (f) (e) (d) (c) (b) (a)	scale:	1:2	surface:	material, semi finished parts:	A2
	drawn	01-02-2023	date	name	CS
	proven	01-03-2023	date	name	(technical requirements Fulterer)
			description:		FR 9000 / 100 EN (mm)
Fulterer AG & Co KG A-6890 Lustenau / Austria Fulterer AG CH-9430 St. Margrethen		drawing number:		9000.1000-GA.0000.li	
changes		date	na.	replaces version date:	

drawn right

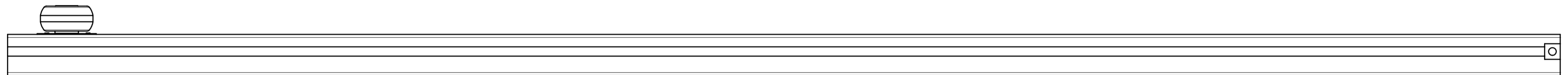
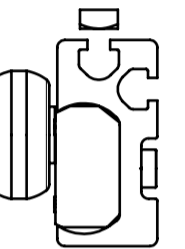
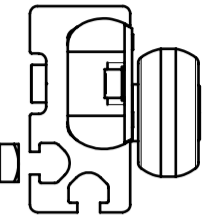
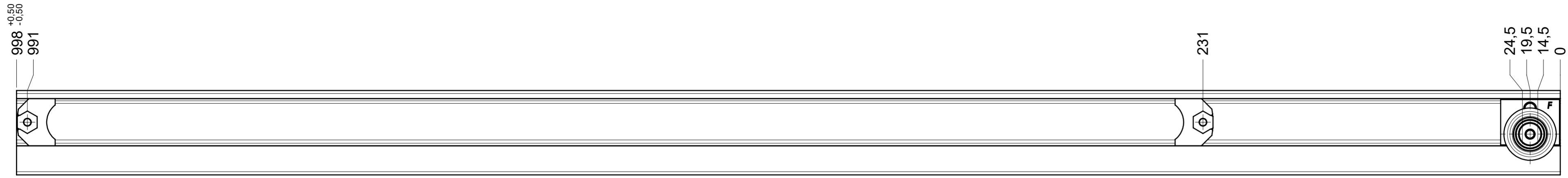

extension 697,9



length 998

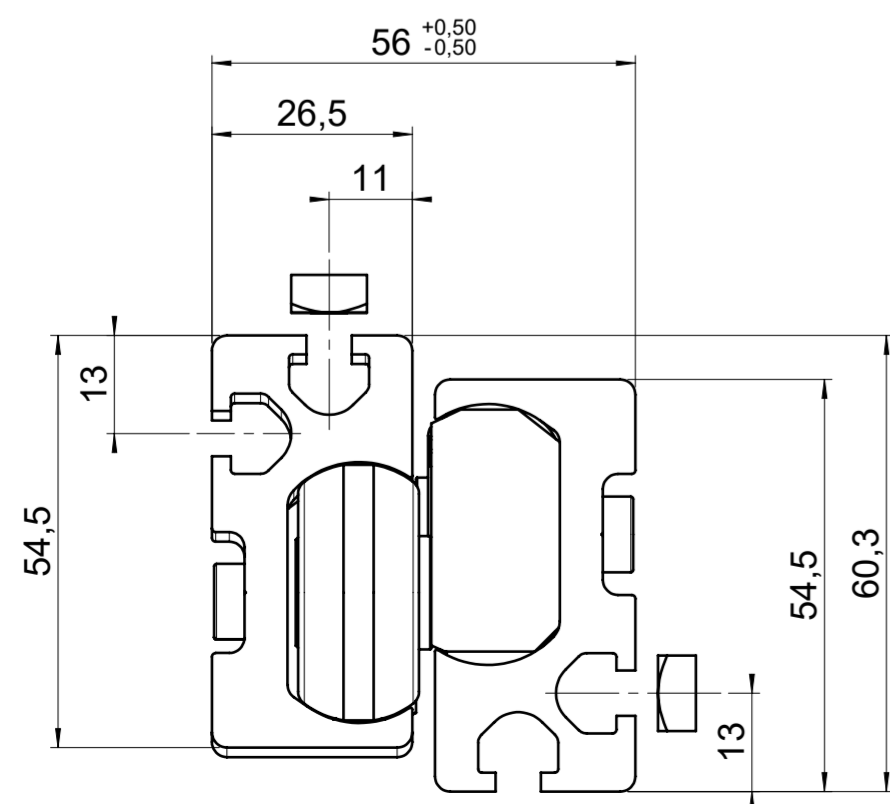
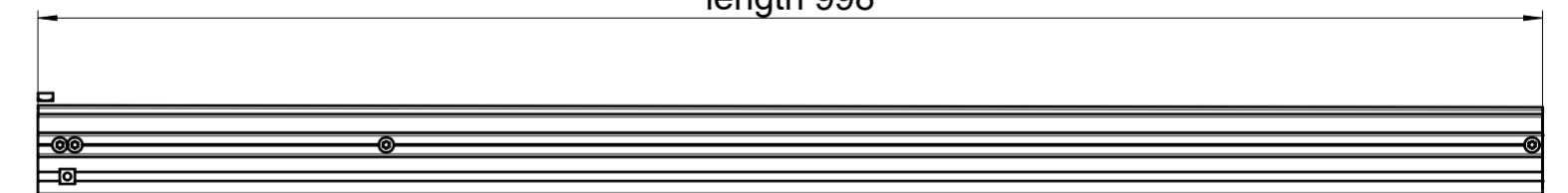

final approval

customer name:

signed by:

date:

all dimensions in mm

DIN ISO 128-30
missing dimensions see 3D
= theor. intersection

This drawing remains our property and may not be multiplied neither be disclosed to third parties (§§1,3 and 5 from the copyright Act (UrhG)) covered according to DIN ISO 16016				scale:	surface:	material, semi finished parts: CS (technical requirements Fulterer)
		1:2			description: FR 9000 / 100 EN (mm) progressive-action full-extension drawerslide / side mount	
(k)			drawn	date		name
(l)			proven	01-02-2023	ex	
(h)				01-03-2023	pr	replaces version date:
(g)						
(f)						
(e)						
(d)						
(c)						
(b)						
(a)						
ind.	changes	date	na.			