

drawn left

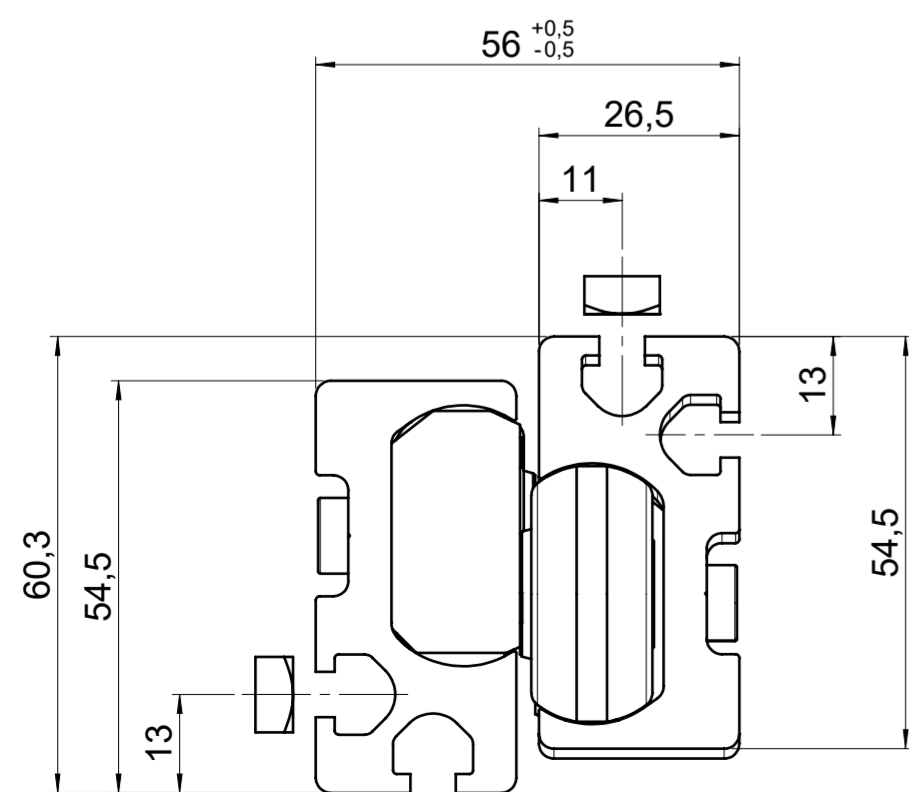
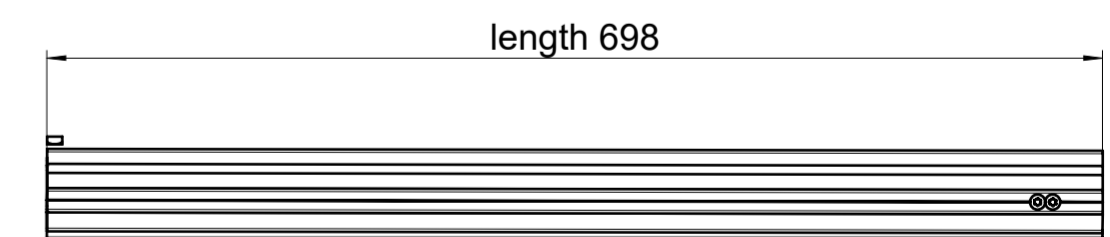
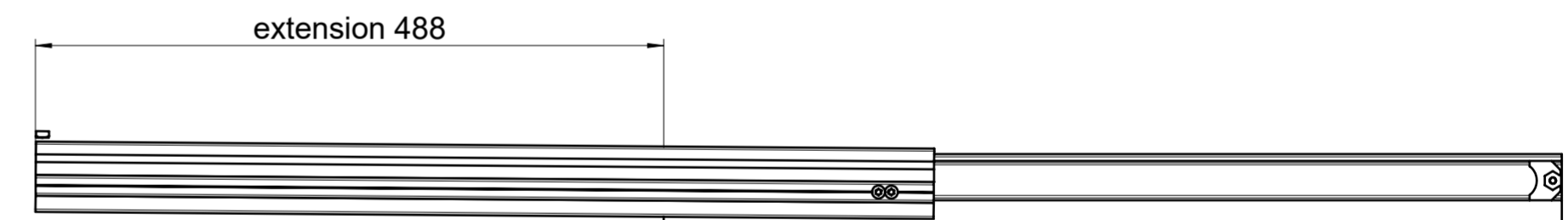
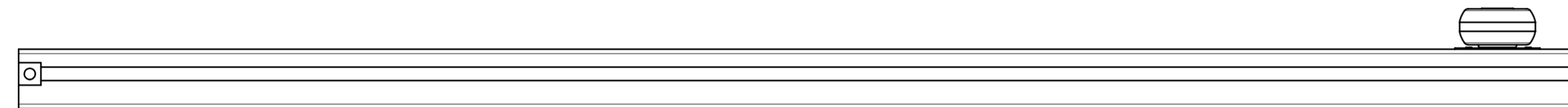
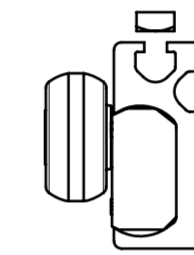
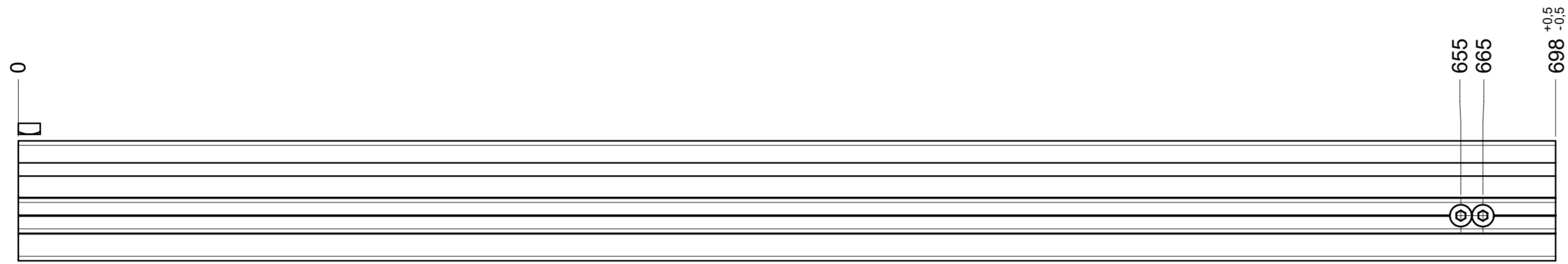
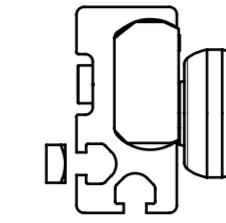
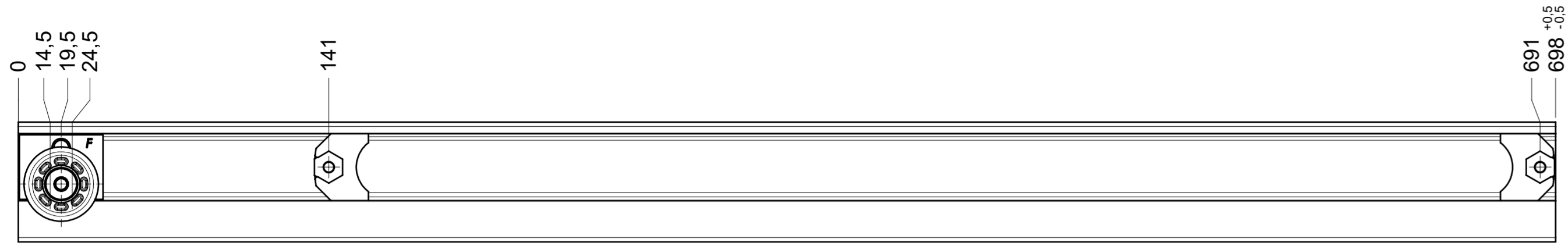

final approval

customer name:

signed by:

date:

all dimensions in mm

DIN ISO 128-30
missing dimensions see 3D
= theor. intersection

This drawing remains our property and may not be multiplied neither be disclosed to third parties (§§1,3 and 5 from the copyright Act (UrhG)) covered according to DIN ISO 16016				scale: 1:2	surface:	material, semi finished parts: CS (technical requirements Fulterer)	A2
(k)				date	name	description: FR 9000 / 70 EN (mm) progressive-action full-extension drawerslide / side mount	drawing number: 9000.700-GA.0000.li replaces version date:
(l)			drawn 01-02-2023	ex			
(m)			proven 01-03-2023	pr			
(n)							
(o)							
(p)							
(q)							
(r)							
(s)							
(t)							
(u)							
(v)							
(w)							
(x)							
(y)							
(z)							
ind.	changes	date	na.				

drawn right

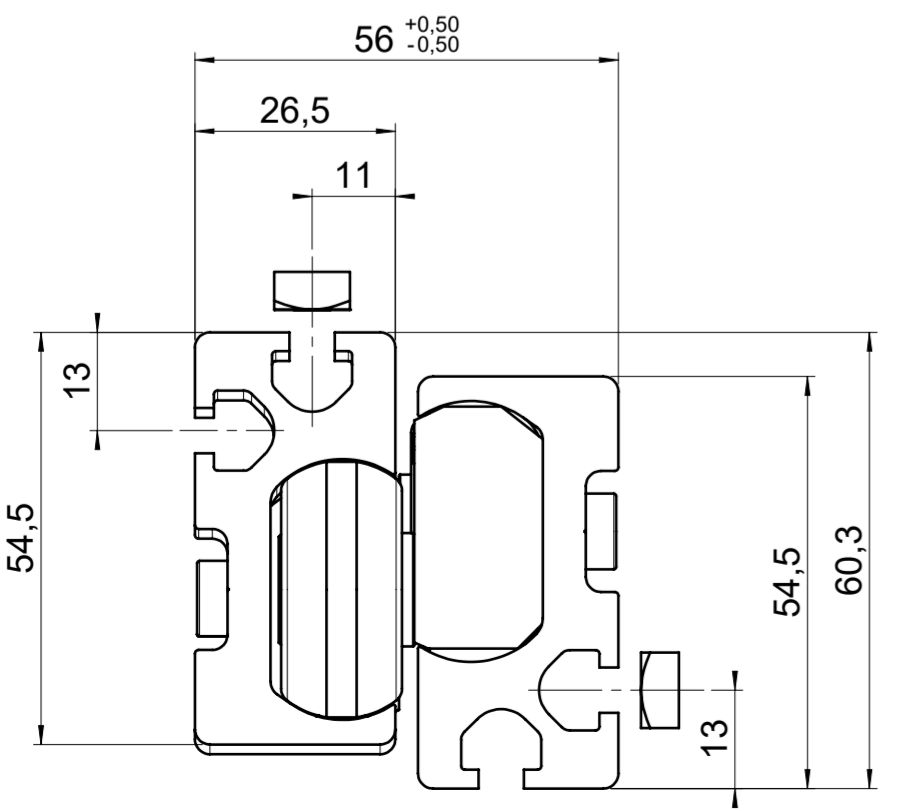
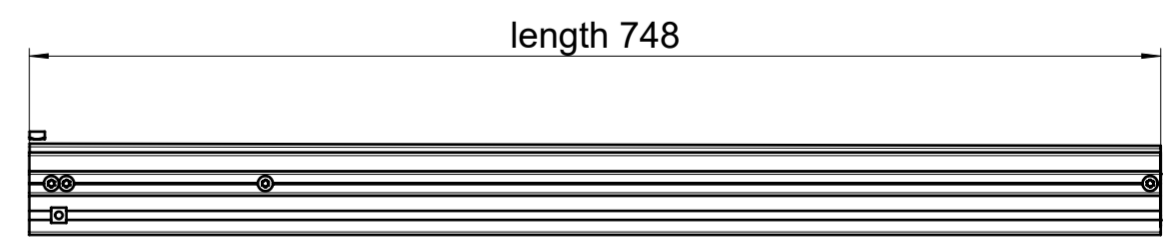
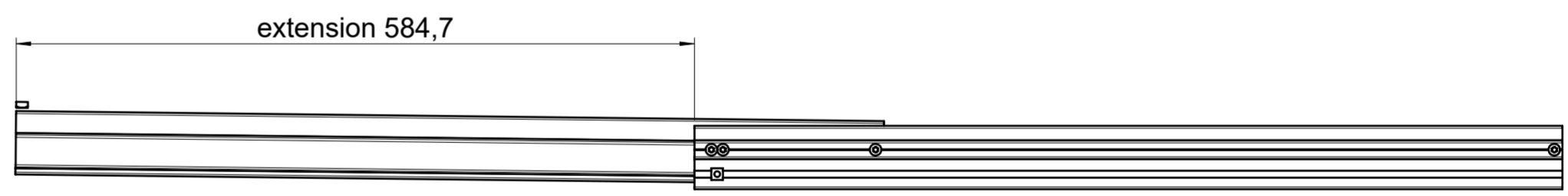
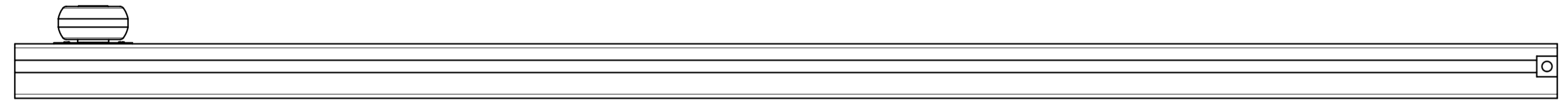
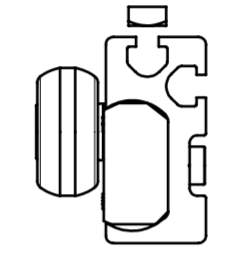
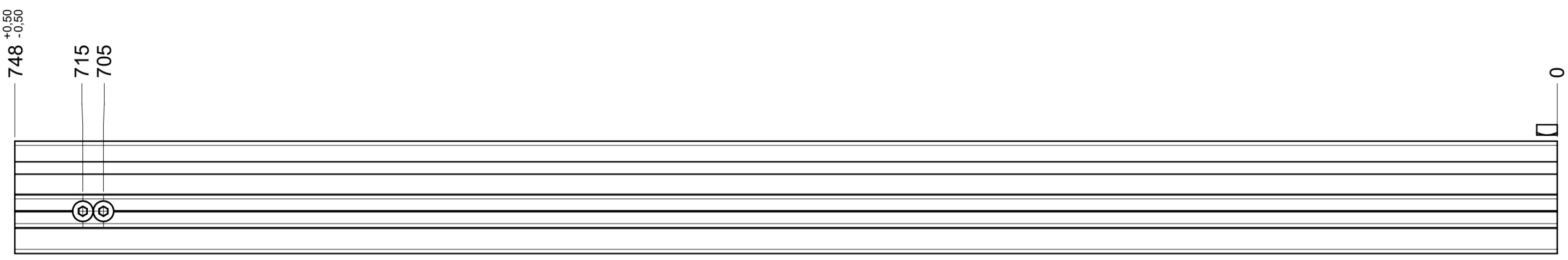
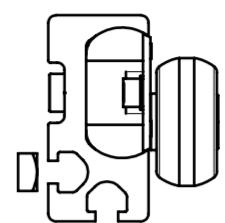
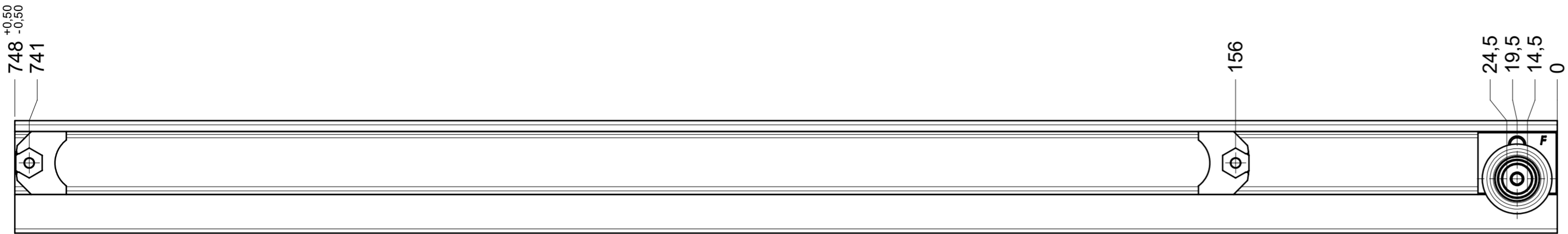

final approval

customer name:

signed by:

date:

all dimensions in mm

DIN ISO 128-30
missing dimensions see 3D
= theor. intersection

This drawing remains our property and may not be multiplied neither be disclosed to third parties (§§1,3 and 5 from the copyright Act (UrhG)) covered according to DIN ISO 16016				scale: 1:2	surface:	material, semi finished parts: CS (technical requirements Fulterer)	A2	
(k)				drawn	date	name	description: FR 9000 / 75 EN (mm) progressive-action full-extension drawerslide / side mount	
(l)				proven	01-02-2023	ex		
(m)					01-03-2023	pr		
(n)							drawing number: 9000.750-GA.0000.re	
(o)								Fulterer AG & Co KG A-6890 Lustenau / Austria Fulterer AG CH-9430 St. Margrethen
(p)				ind.	changes	date	na.	replaces version date: