

drawn left

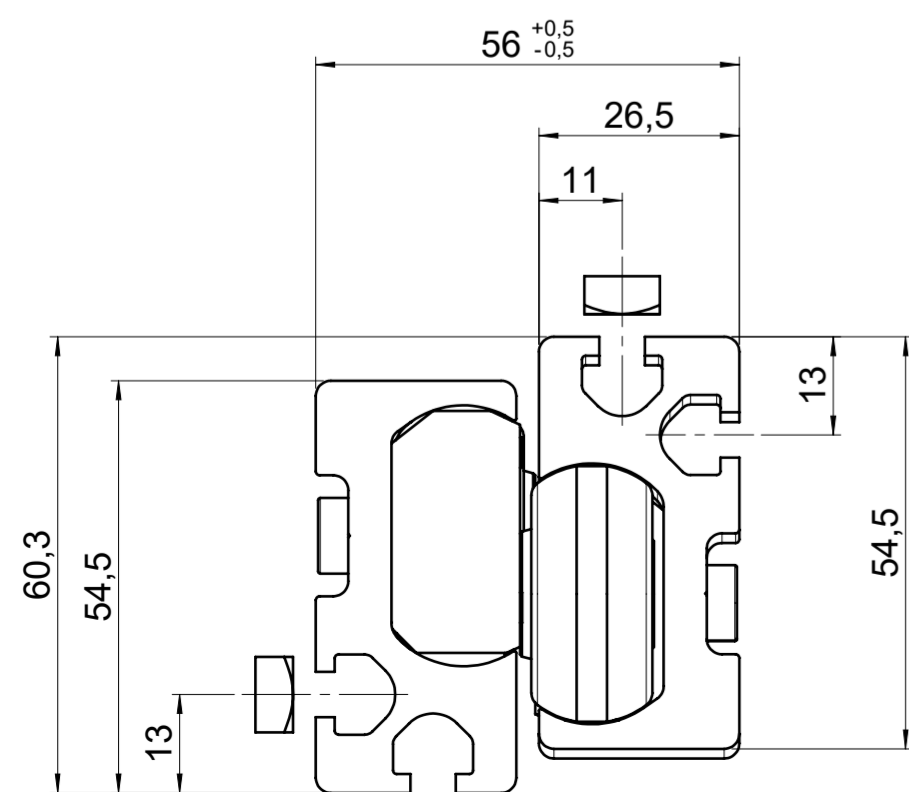
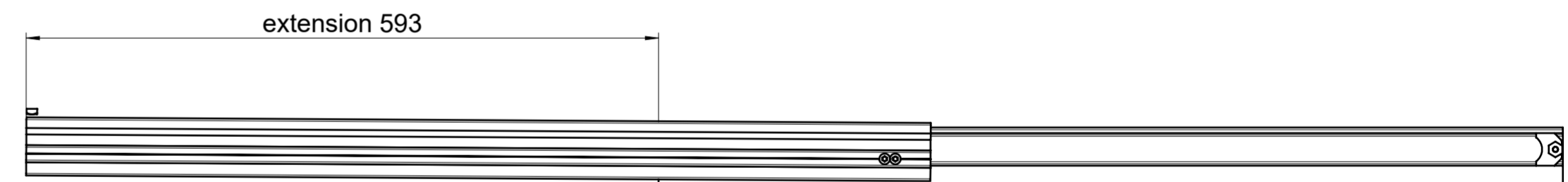
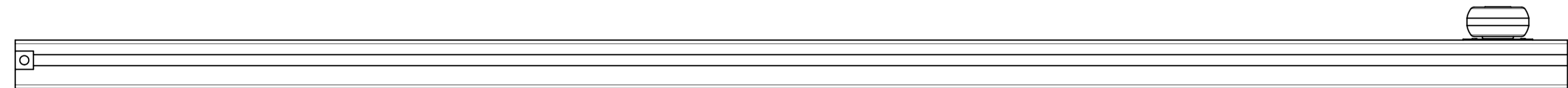
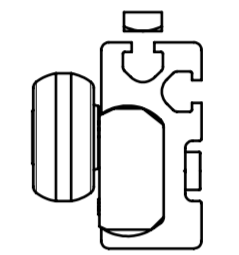
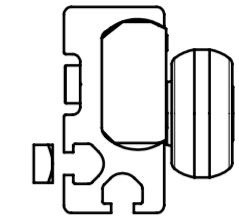
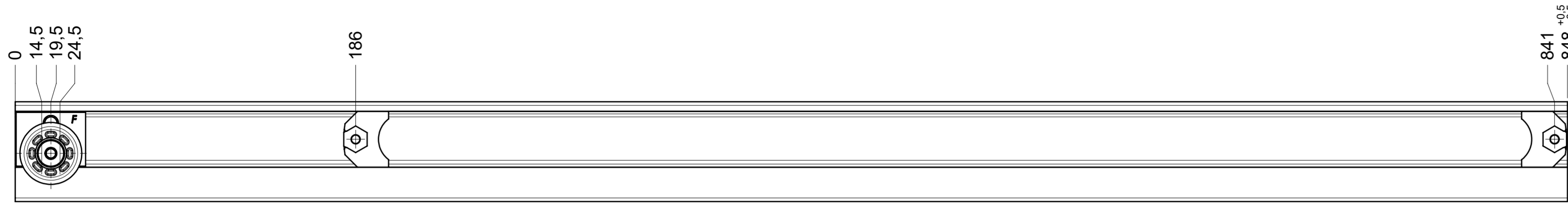

final approval

customer name:

signed by:

date:

all dimensions in mm

DIN ISO 128-30
missing dimensions see 3D
= theor. intersection

This drawing remains our property and may not be multiplied neither be disclosed to third parties (§§1,3 and 5 from the copyright Act (UrhG)) covered according to DIN ISO 16016

(k) (l) (i) (h) (g) (f) (e) (d) (c) (b) (a)	scale:	1:2	surface:	material, semi finished parts:	A2
	drawn	01-02-2023	date	name	CS
	proven	01-03-2023	date	name	(technical requirements Fulterer)
	description: FR 9000 / 85 EN (mm) progressive-action full-extension drawerslide / side mount		drawing number: 9000.850-GA.0000.li replaces version date:		
ind.	changes	date	na.	Fulterer AG & Co KG A-6890 Lustenau / Austria Fulterer AG CH-9430 St. Margrethen	

drawn right

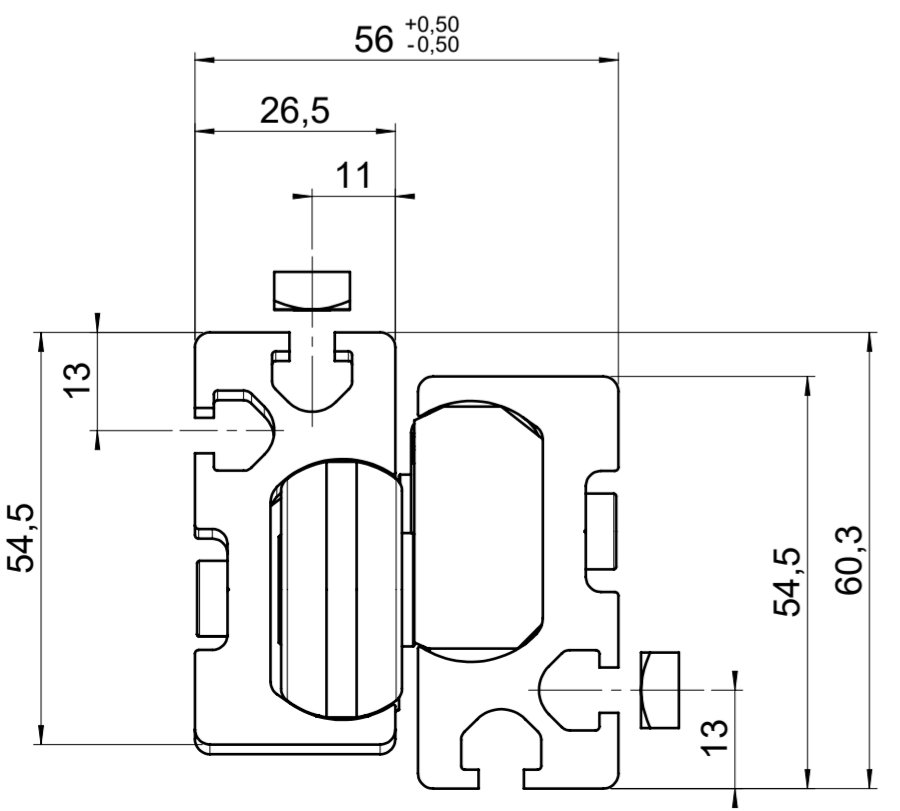
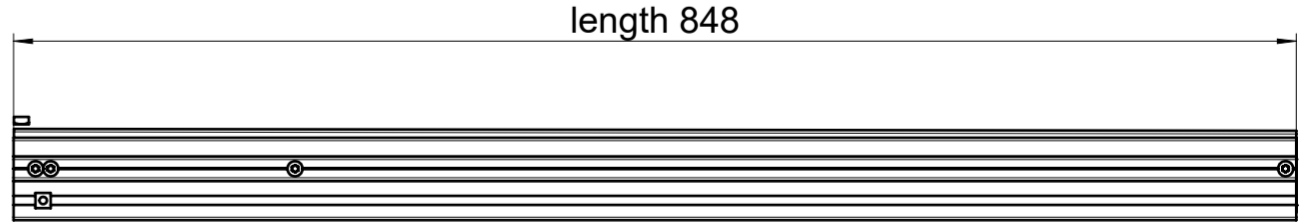
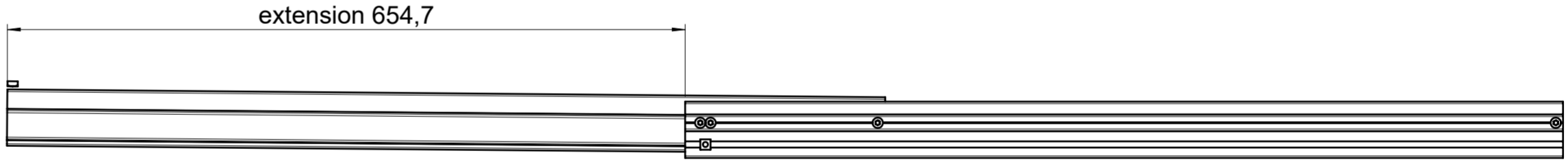
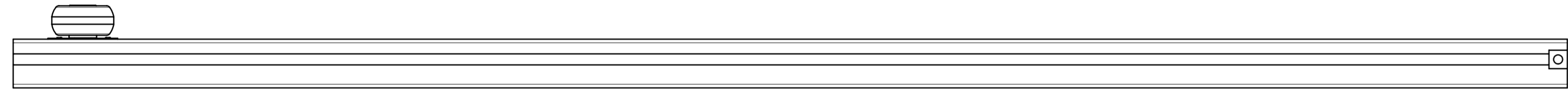
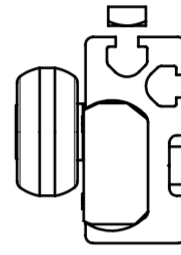
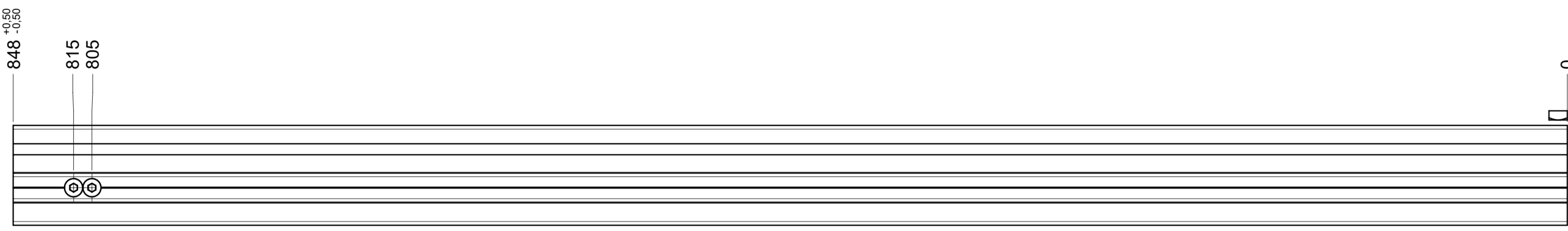
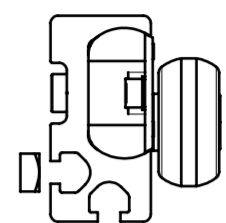
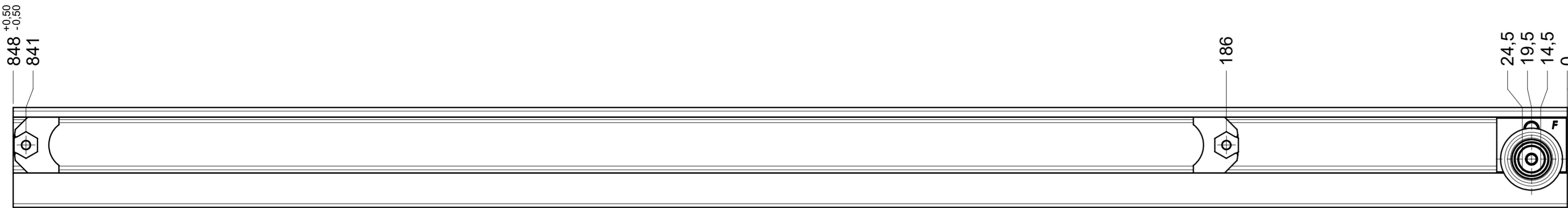

final approval

customer name:

signed by:

date:

all dimensions in mm				DIN ISO 128-30 missing dimensions see 3D = theor. intersection	
This drawing remains our property and may not be multiplied neither be disclosed to third parties (§§1,3 and 5 from the copyright Act (UrhG)) covered according to DIN ISO 16016					
scale: 1:2		surface:		material, semi finished parts: CS (technical requirements Fulterer)	
drawn 01-02-2023		date 01-02-2023		description: FR 9000 / 85 EN (mm) progressive-action full-extension drawerslide / side mount	
proven 01-03-2023		name ex		drawing number: 9000.850-GA.0000.re	
		pr		replaces version date:	
Fulterer		Fulterer AG & Co KG A-6890 Lustenau / Austria			
		Fulterer AG CH-9430 St. Margrethen			
ind.	changes	date	na.		