

DRAWER WIDTH = CABINET OPEING WIDTH - 10mm
WITH 16mm WALL THICKNESS

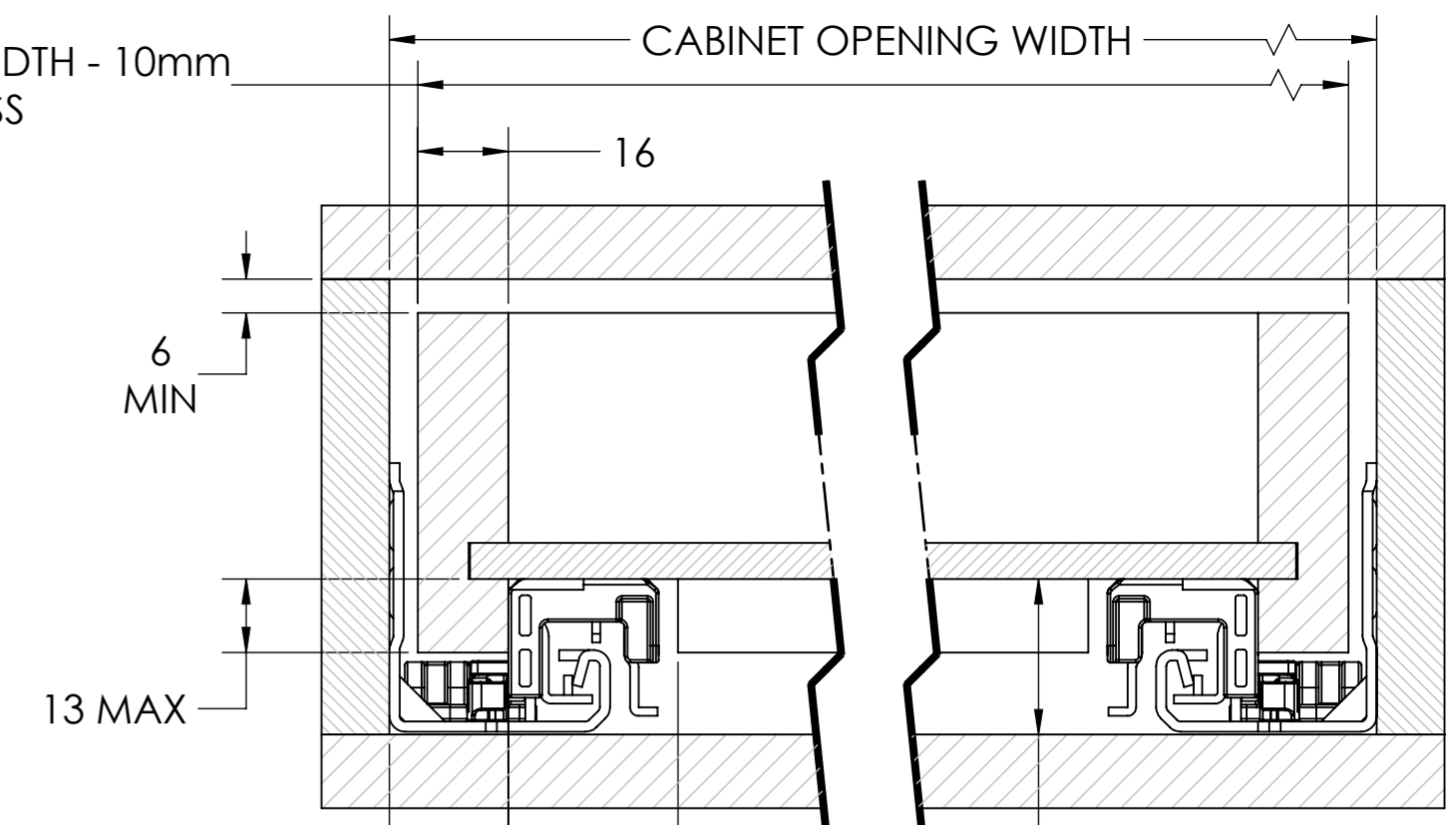

SCALE 3:4

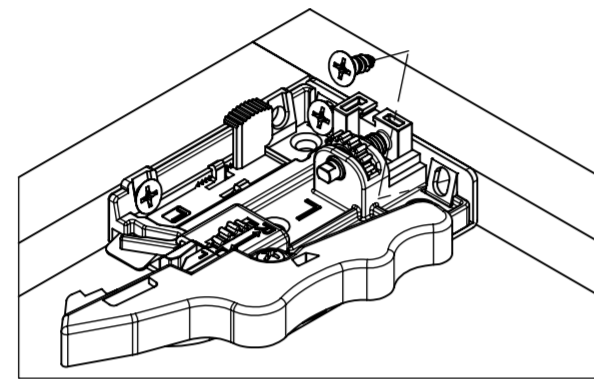

LOCKING KIT
FRONT/SIDE MOUNT
SCALE 1:1.5

CABINET MOUNTING HOLES

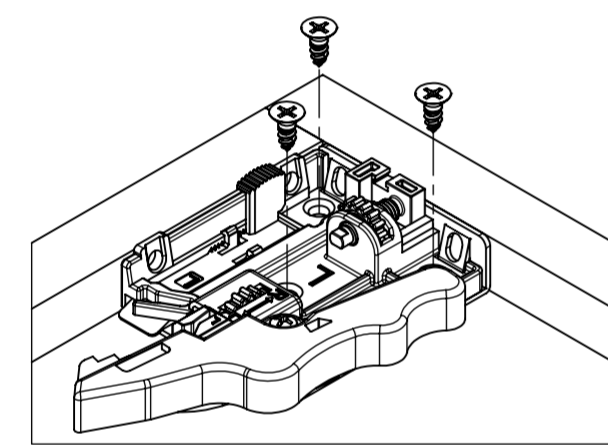
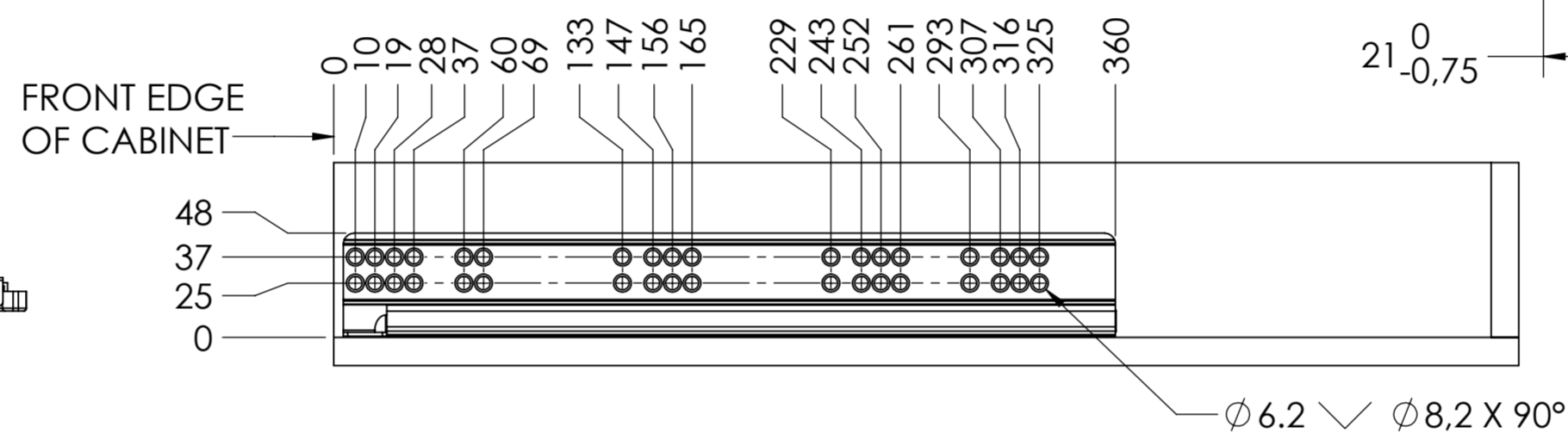

LOCKING KIT
BOTTOM MOUNT
SCALE 1:1.5

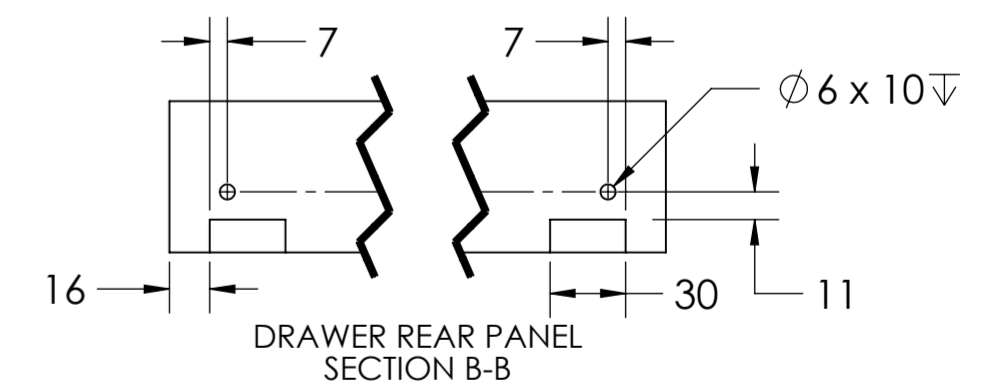
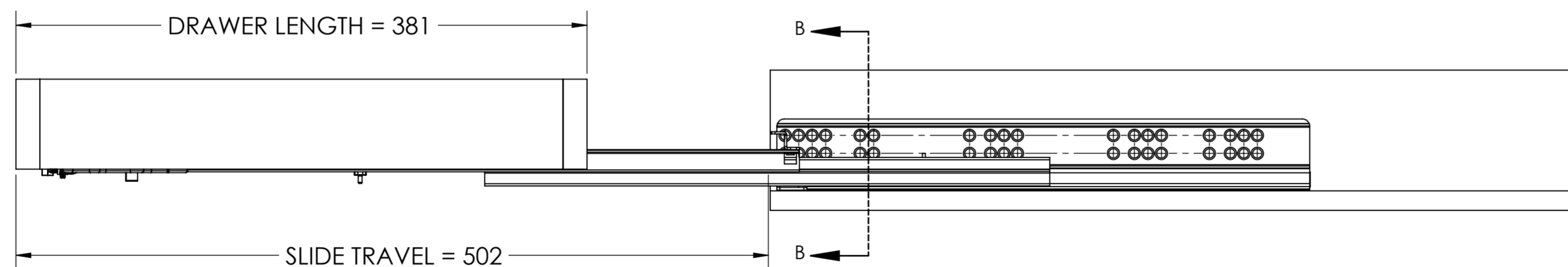
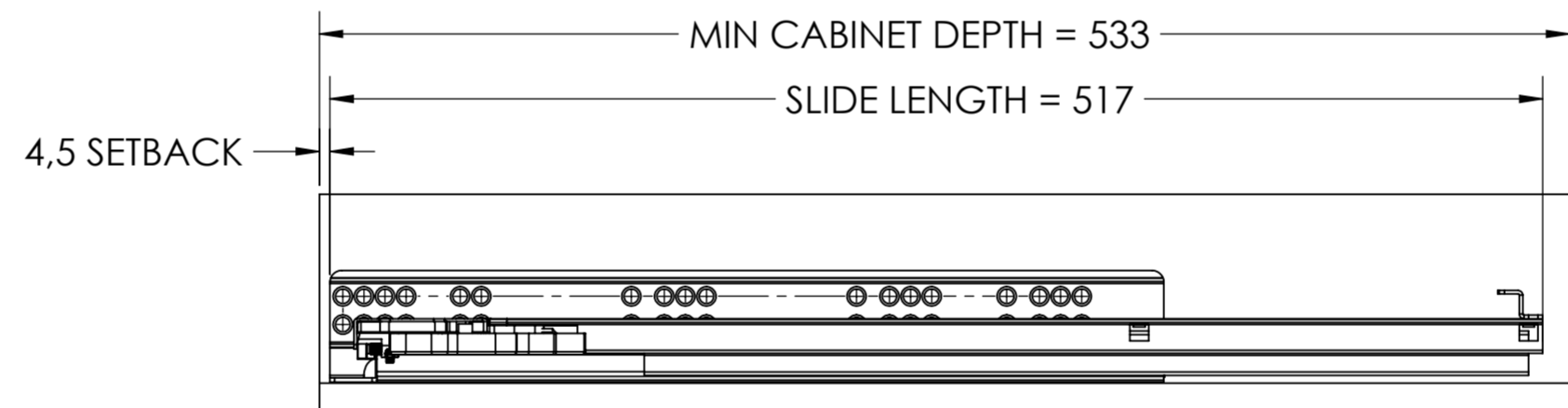

RECOMMENDED HARDWARE:

CABINET- M4 OR #6 FLATHEAD SCREWS

DRAWER LOCKING KIT- M3 OR #6 FLATHEAD SCREW

NOTE: LOCKING KIT INCLUDED WITH SLIDE

general tolerances		DIN ISO 128-30 missing dimensions see 3D = theor. intersection	
ISO 2768-m			
This drawing remains our property and may not be multiplied neither be disclosed to third parties (§§1,3 and 5 from the copyright Act (UrhG)) covered according to DIN ISO 16016			
(k)	scale:	1:3	surface:
(l)	date:	24-04-2019	name:
(m)	drawn:	HB	
(n)	proven:	00-00-0000	00
(o)	Fulterer		material, semi finished parts:
(p)			STEEL
(q)	Fulterer AG & Co KG A-6890 Lustenau / Austria		(technical requirements Fulterer)
(r)	Fulterer AG CH-9430 St. Margrethen		description:
(s)			UNDERMOUNT FULL EXTENSION SOFT CLOSE SLIDE WITH 3 WAY LOCKING KIT
(t)			drawing number:
(u)			3002.518-GA.C047
(v)			replaces version date:
(w)	changes	date	na.