

DRAWER WIDTH = CABINET OPEING WIDTH - 10mm  
WITH 16mm WALL THICKNESS

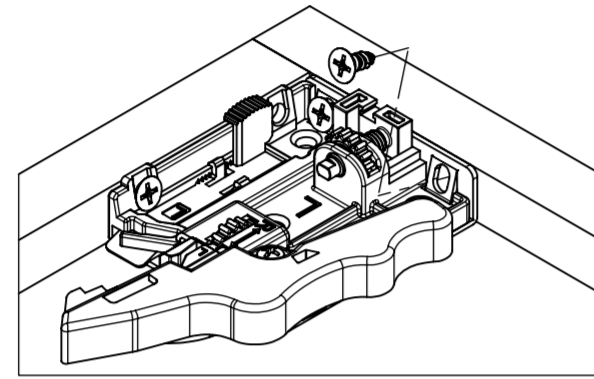

LOCKING KIT  
FRONT/SIDE MOUNT  
SCALE 1:1.5

### CABINET MOUNTING HOLES

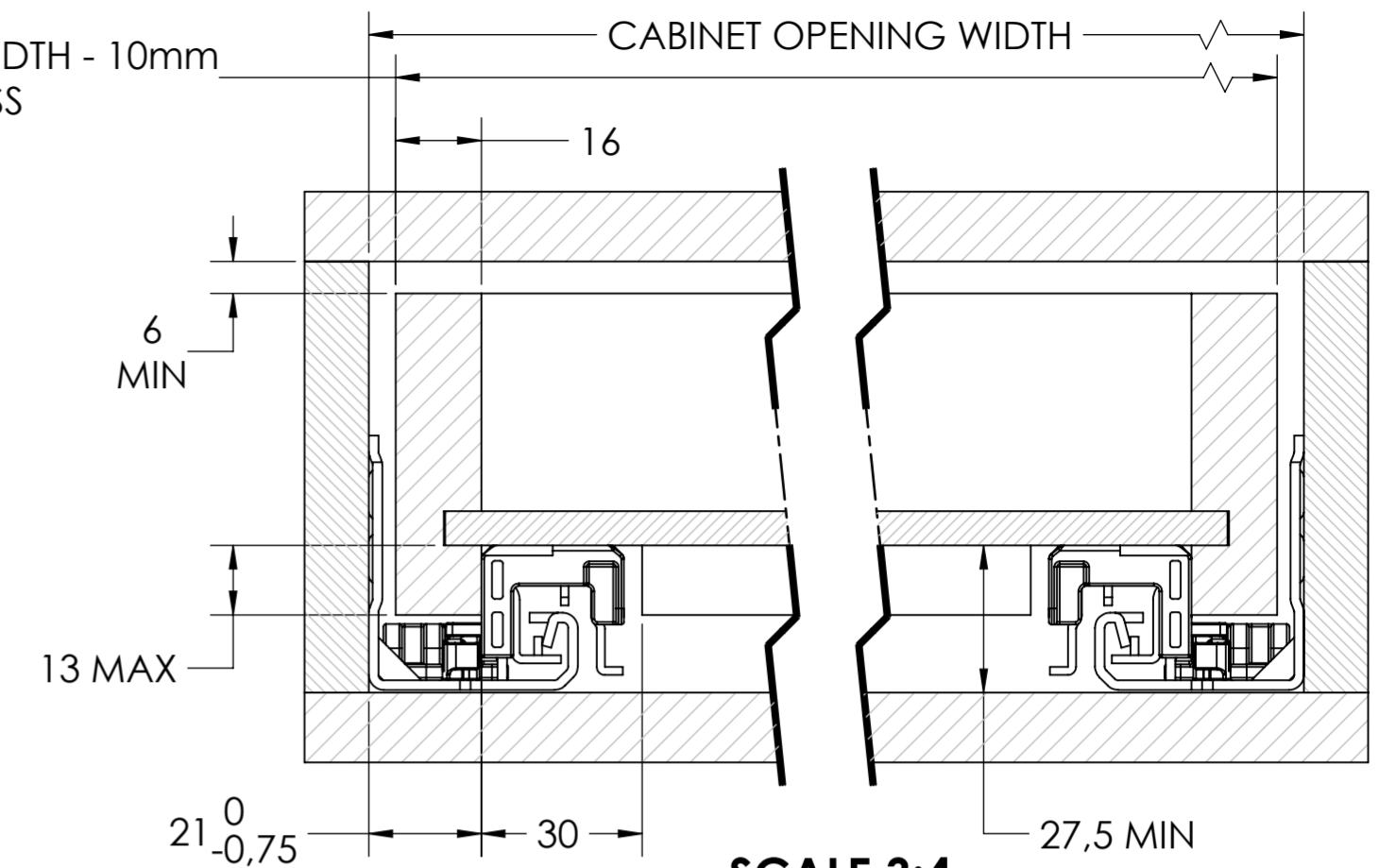
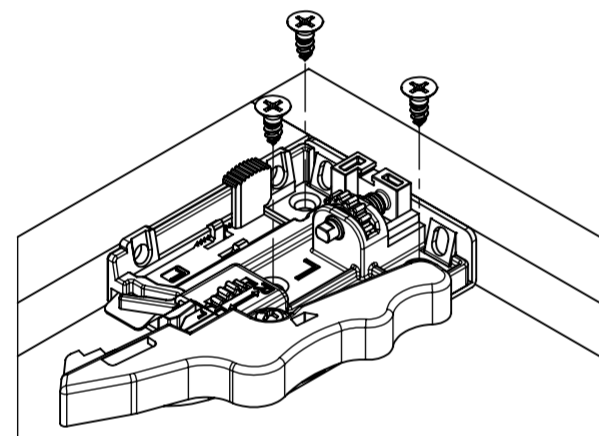
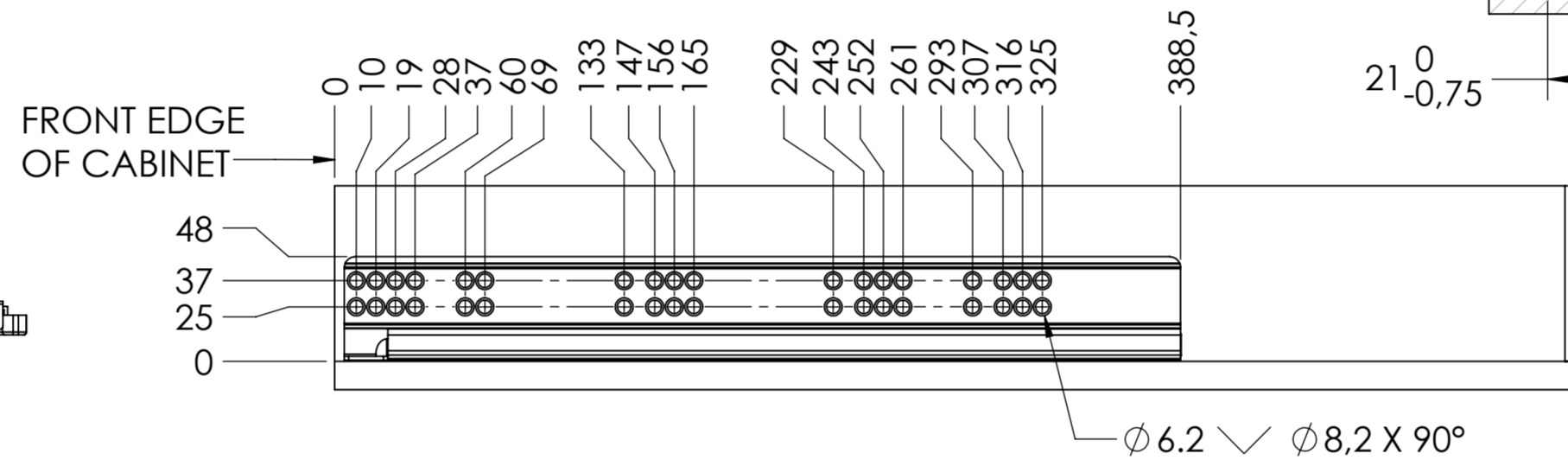

LOCKING KIT  
BOTTOM MOUNT  
SCALE 1:1.5

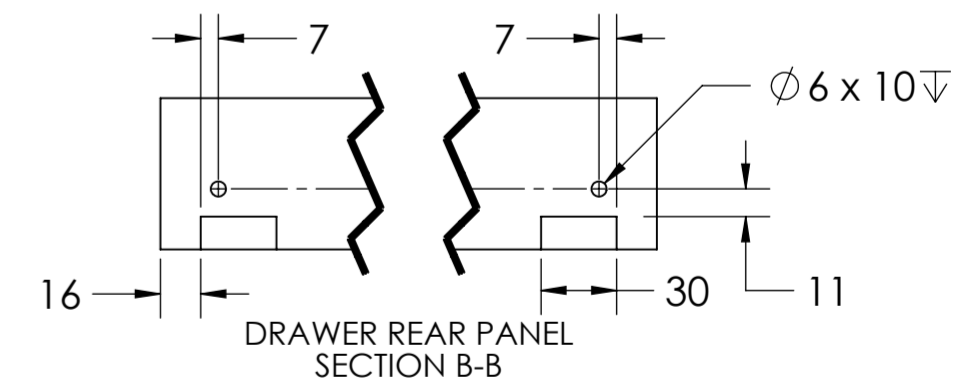
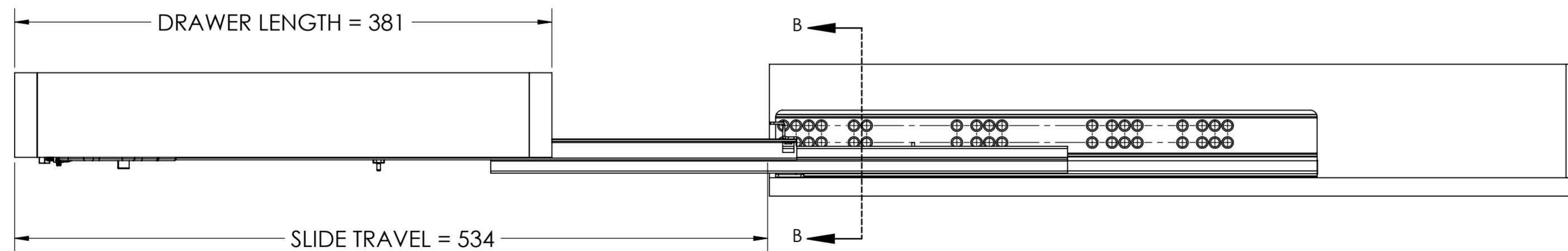
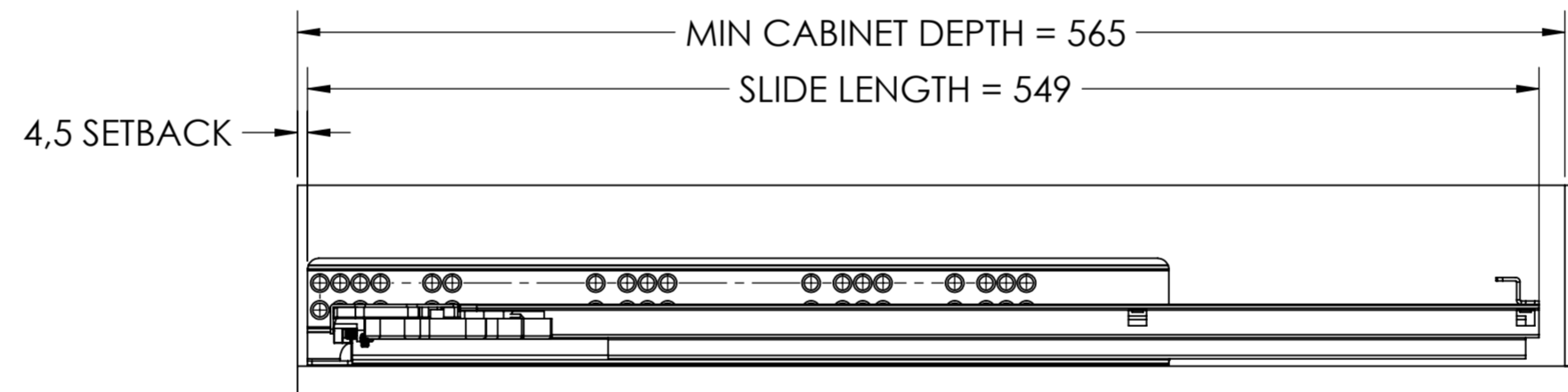

#### RECOMMENDED HARDWARE:

CABINET- M4 OR #6 FLATHEAD SCREWS

DRAWER LOCKING KIT- M3 OR #6 FLATHEAD SCREW

**NOTE:** LOCKING KIT INCLUDED WITH SLIDE

general tolerances		DIN ISO 128-30 missing dimensions see 3D = theor. intersection	
ISO 2768-m			
This drawing remains our property and may not be multiplied neither be disclosed to third parties (§§1,3 and 5 from the copyright Act (UrhG))			
covered according to DIN ISO 16016		scale:	surface:
(k)		1:3	
(l)		date	name
(m)		drawn 24-04-2019	HB
(n)		proven 00-00-0000	00
(o)		<b>Fulterer</b>	
(p)			
(q)		Fulterer AG & Co KG A-6890 Lustenau / Austria	
(r)		Fulterer AG CH-9430 St. Margrethen	
(s)		drawing number: <b>3002.550-GA.C047</b>	
(t)		replaces version date:	
(u)			
(v)			
(w)			
(x)			
(y)			
(z)			
ind.	changes	date	na.