

SCALE 1:1

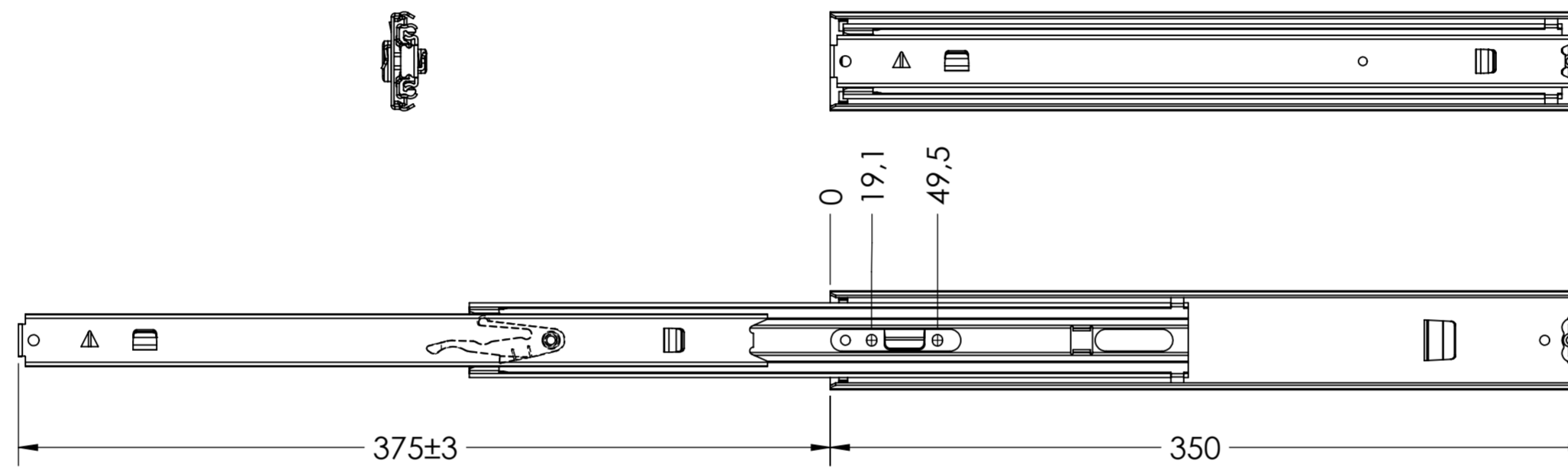

DRAWER MOUNTING CUTOUTS

CABINET MOUNTING CUTOUTS

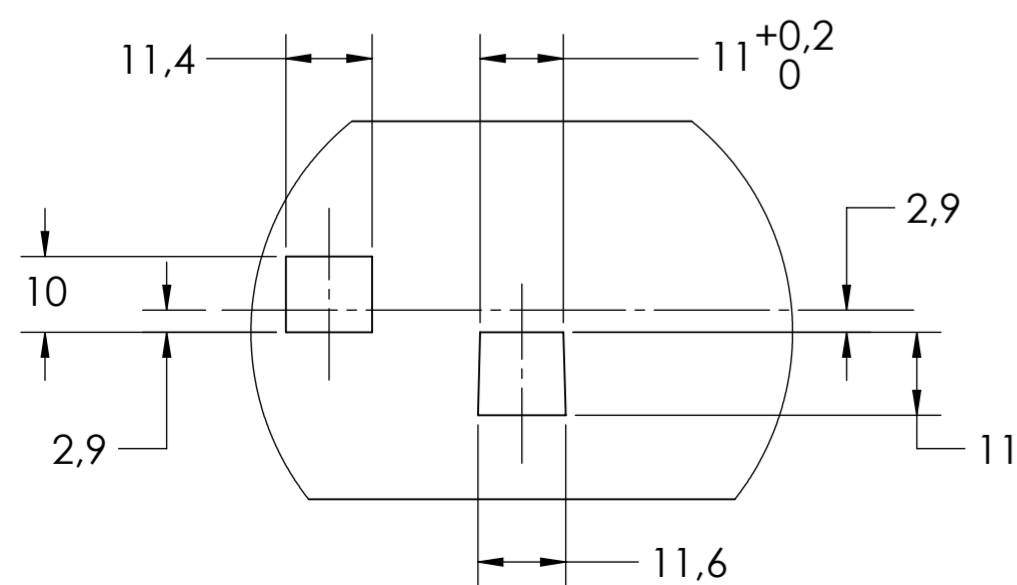
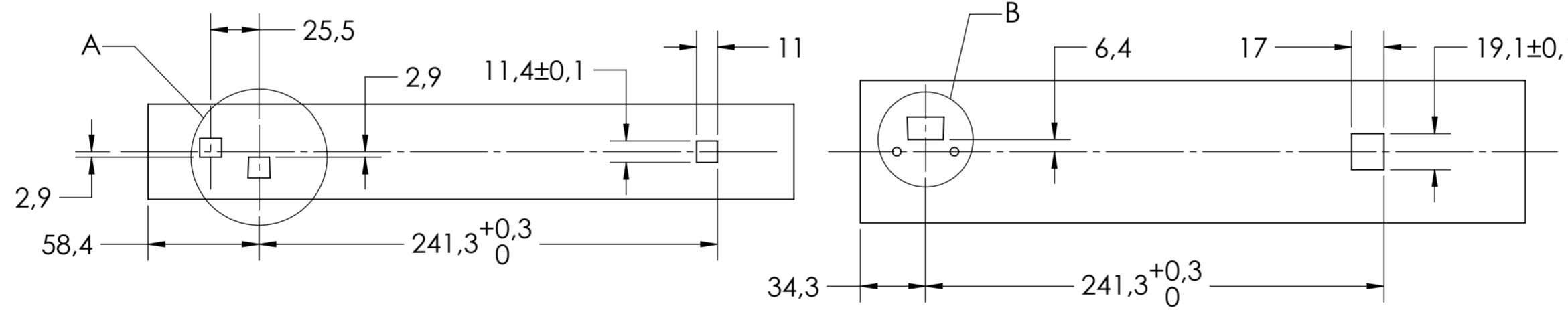

DETAIL A
SCALE 1:1

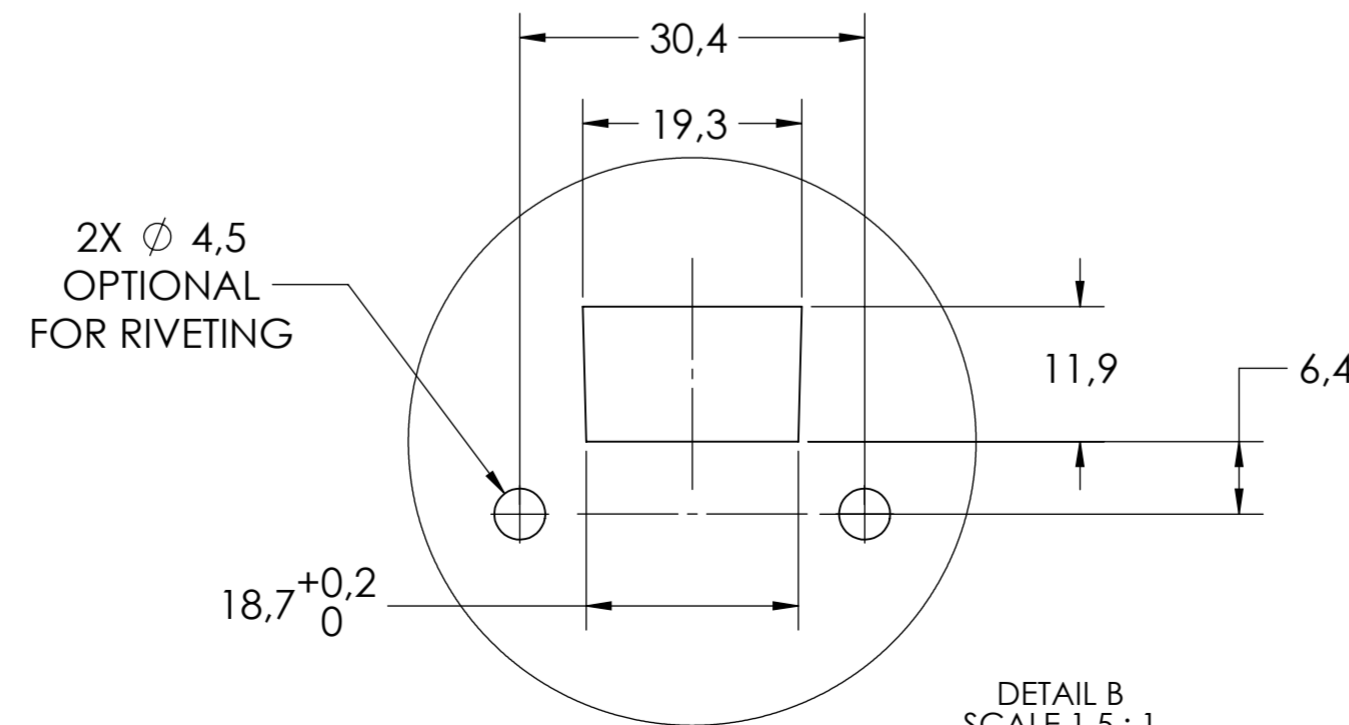

DETAIL B
SCALE 1.5:1

general tolerances		DIN ISO 128-30 missing dimensions see 3D = theor. intersection	
ISO 2768-m			
This drawing remains our property and may not be multiplied neither be disclosed to third parties (§§1,3 and 5 from the copyright Act (UrhG)) covered according to DIN ISO 16016			
scale: 3:8		surface: A2	
drawn: 21-05-2019		name: HB	
proven: 00-00-0000		00	
Fulterer		description: SIDE MOUNT OVER EXTENSION SMT (1.5) DRAWER SLIDE WITH DRAWER DISCONNECT	
Fulterer AG & Co KG A-6890 Lustenau / Austria		drawing number: 5000.350-GA.T103	
Fulterer AG CH-9430 St. Margrethen		replaces version date:	
ind.	changes	date	na.