

SCALE 1:1

32 REF.

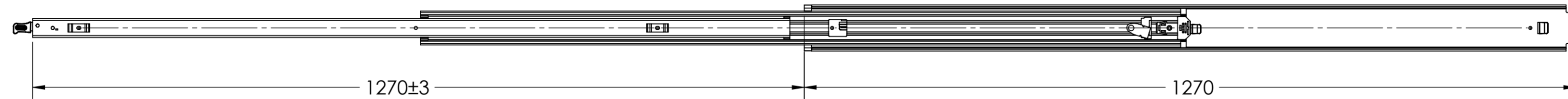
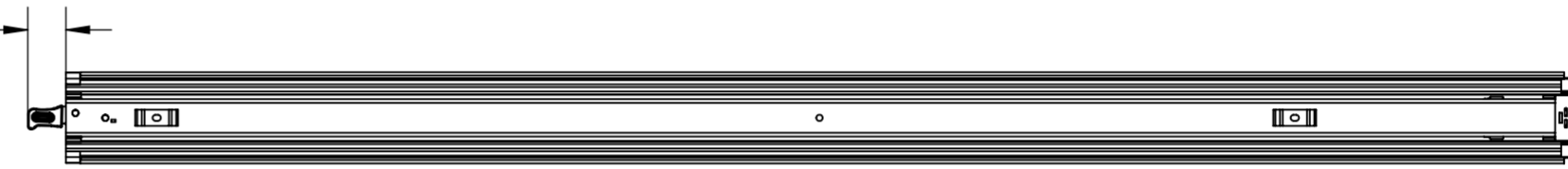

DRAWER MOUNTING CUTOUTS

CABINET MOUNTING CUTOUTS

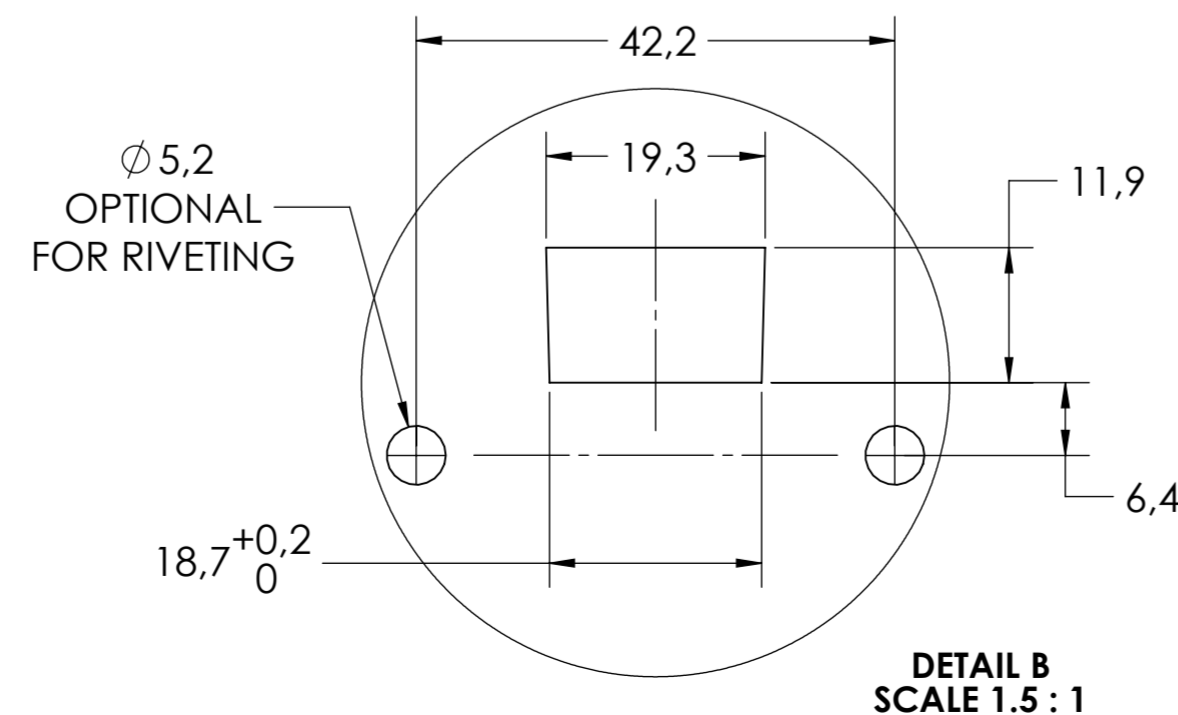
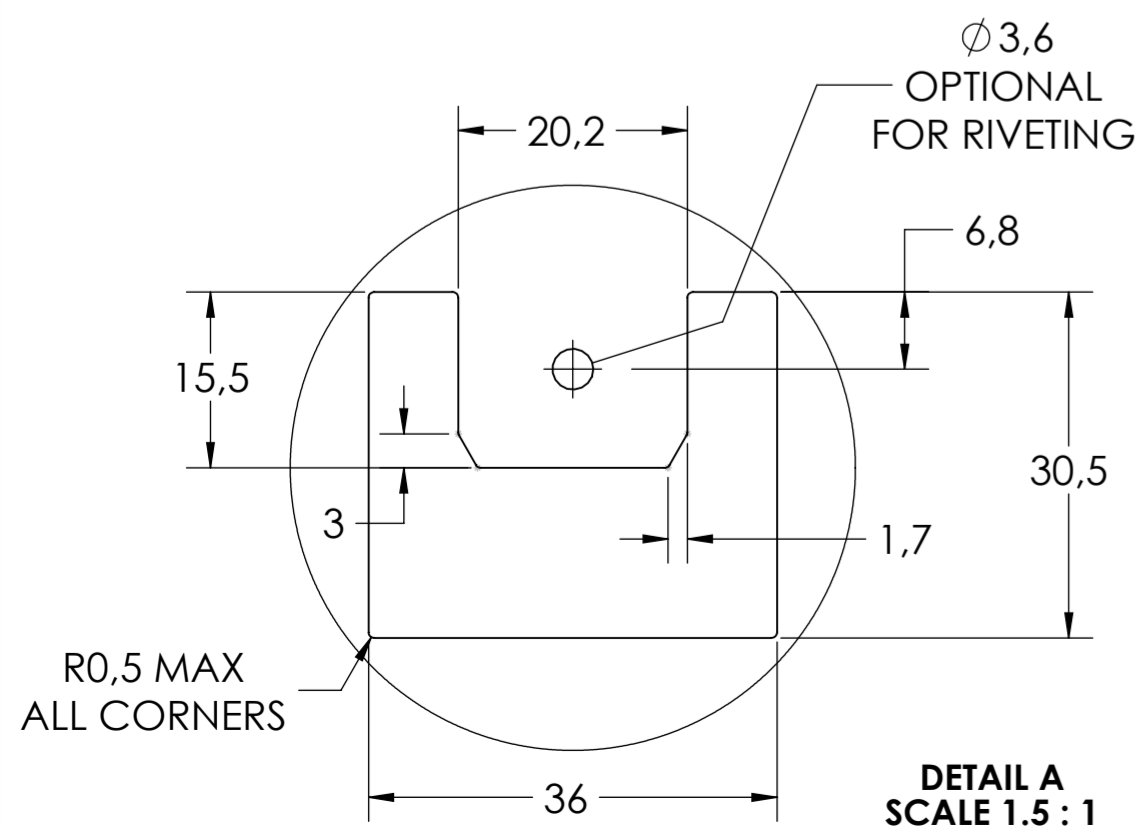
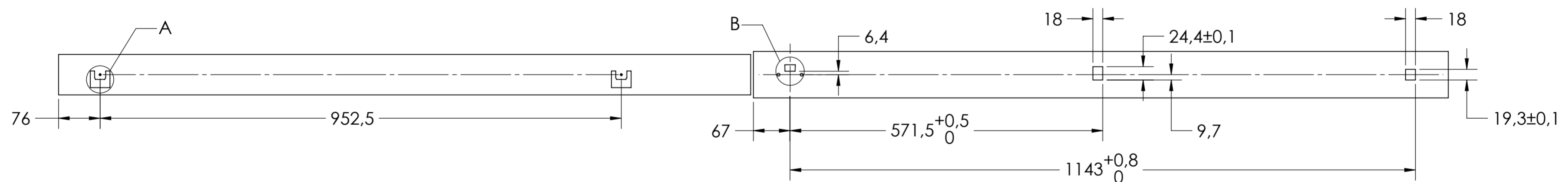

general tolerances		DIN ISO 128-30 missing dimensions see 3D = theor. intersection	
ISO 2768-m			
This drawing remains our property and may not be multiplied neither be disclosed to third parties (§§1,3 and 5 from the copyright Act (UrhG))			
covered according to DIN ISO 16016		scale:	surface:
(k)		1:6	
(l)		date	name
(m)		drawn 24-07-2019	HB
(n)		proven 00-00-0000	00
(o)		Fulterer	
(p)			
(q)		Fulterer AG & Co KG A-6890 Lustenau / Austria	
(r)		Fulterer AG CH-9430 St. Margrethen	
(s)		drawing number: 5400.50-GA.T118	
(t)		replaces version date:	
(u)	0	00-00-0000	0
ind.	changes	date	na.