

SCALE 1:1

DISCONNECT RAIL

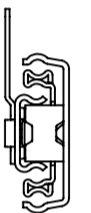
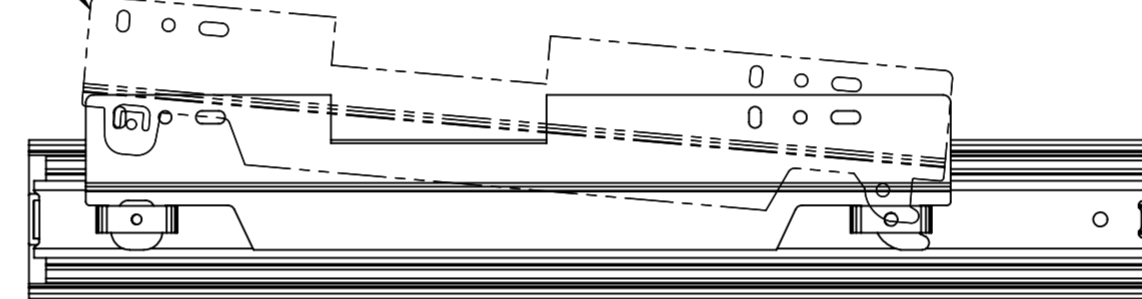
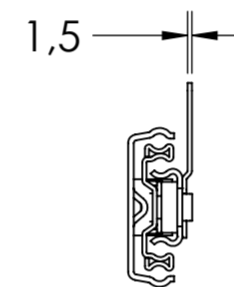

CABINET MOUNTING HOLES

∅ 5,8 THRU
M4 FLAT HEAD

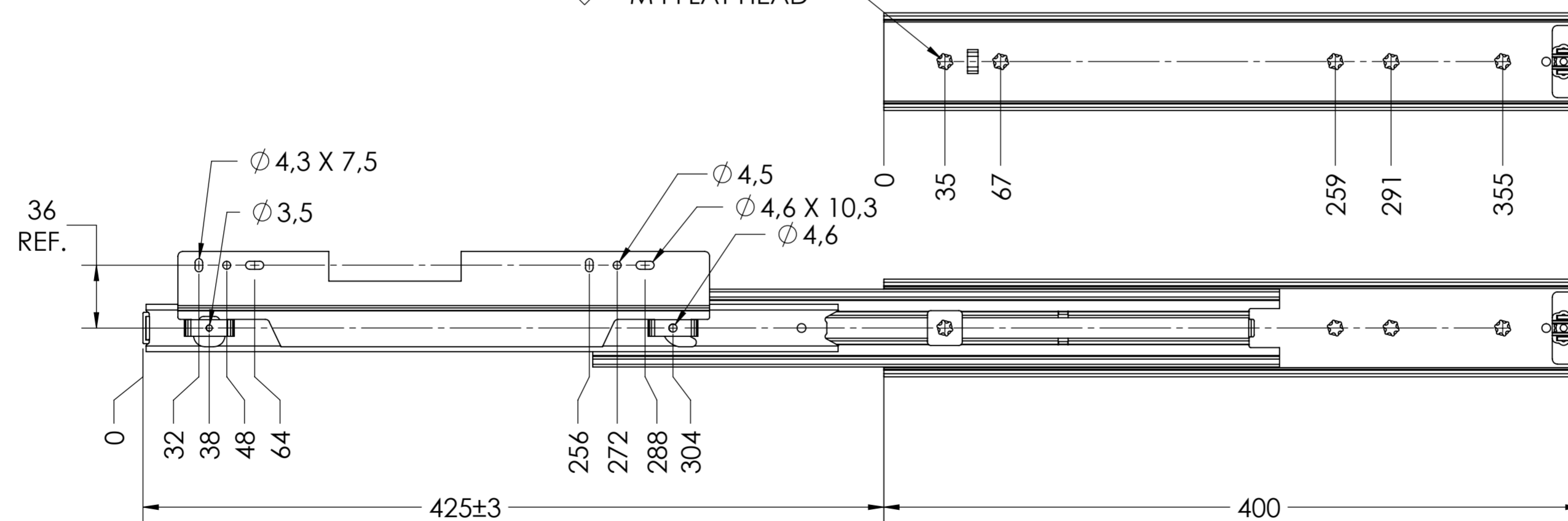

RECOMMENDED HARDWARE:

CABINET- M4 FLAT HEAD SCREW OR #10 FLAT HEAD SCREW

DRAWER- M4 BUTTON HEAD SCREW OR #8 BUTTON HEAD SCREW

general tolerances		DIN ISO 128-30 missing dimensions see 3D = theor. intersection	
ISO 2768-m			
This drawing remains our property and may not be multiplied neither be disclosed to third parties (§§1,3 and 5 from the copyright Act (UrhG)) covered according to DIN ISO 16016			
(k)		scale:	surface:
(l)		3:8	
(m)		date	name
(n)		drawn 27-09-2019	HB
(o)		proven 00-00-0000	00
(p)		Fulterer	
(q)			
(r)		Fulterer AG & Co KG A-6890 Lustenau / Austria	
(s)		Fulterer AG CH-9430 St. Margrethen	
(t)		drawing number: 5623.400-GA.T040	
(u)		replaces version date:	
(v)			
(w)			
(x)			
(y)			
(z)			
ind.	changes	date	na.